

40019863

Original mounting instruction

11/17/20

PVA

DE Montageanleitung

ES Instrucciones de montaje

FR Instructions de montage

GB Assembly Instructions

IT Istruzione di montaggio

NL Montagehandleiding

PL Instrukcja montażu

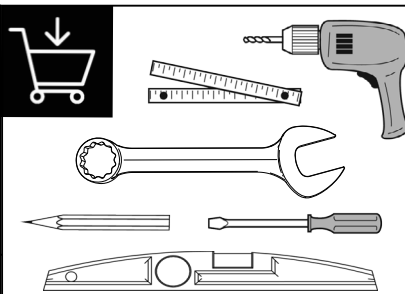
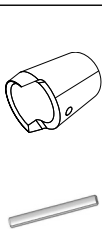

- **Entlüftung mit dirigierbarem Wasserstrahl:** Schrauben Sie die Entlüftung auf den Heizkörper, so dass der Dichtungsring die Dichtigkeit gewährleistet (**15 Nm max**).

- **Purgador de chorro orientable:** Apriete con moderación el purgador en el radiador para obtener la hermeticidad por medio de la junta torica (**15 Nm max**).

- **Purgeur à jet orientable:** Serrez modérément le purgeur sur le radiateur pour faire étanchéité à l'aide du joint torique (**15 Nm max**).

- **Swivelling air bleed valve:** Tighten the bleed valve moderately on the radiator with the o-ring to ensure watertightness. (**15 Nm max**).

- **Rubinetto di sfiato a getto orientabile:** Serrare moderatamente il rubinetto di sfiato situato sul radiatore per ottenere la tenuta mediante O-ring (**15 Nm max**).

- **Orienteerbare ontluchter:** De ontluchter met mate op de radiator aanschroeven zodanig dat met de rubberen dichtingsring een hechte dichting bekomen wordt (**15 Nm max**).

- **Odpowietrzanie przy użyciu odpowietznika obrotowego:** Umiarkowanie dokręcić odpowietznik do grzejnika, zapewniając szczelność przy użyciu uszczelki (**15 Nm max**).

L	H
517	1411
517	1707
617	1855
717	2003

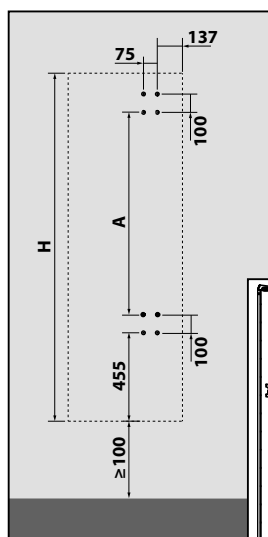
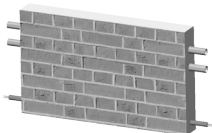
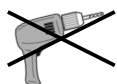
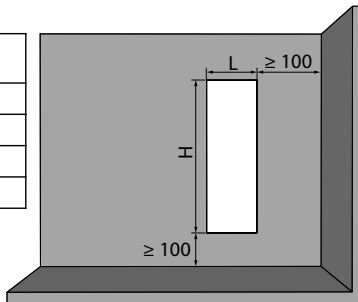

H	A
1411	600
1707	900
1855	1100
2003	1100

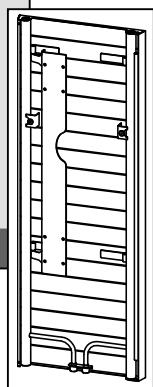
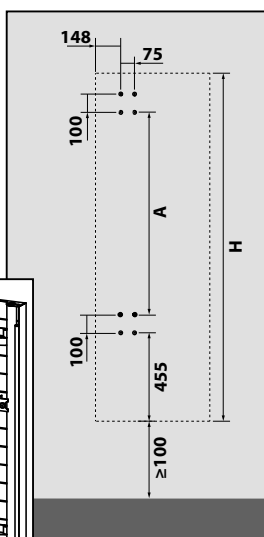

≠

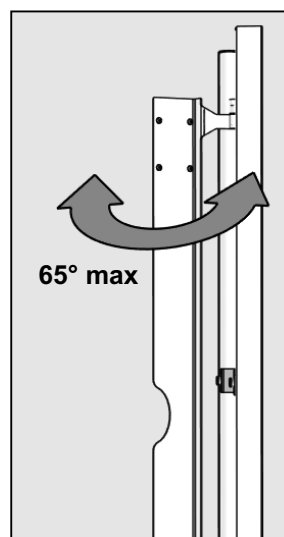
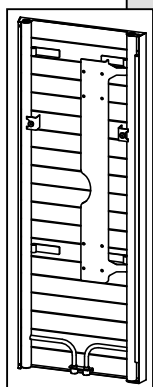

65° max

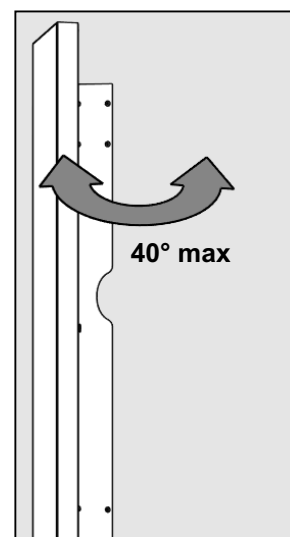

40° max

