

# Montageanleitung Mirror für Spiegel mit und ohne Ablagetisch

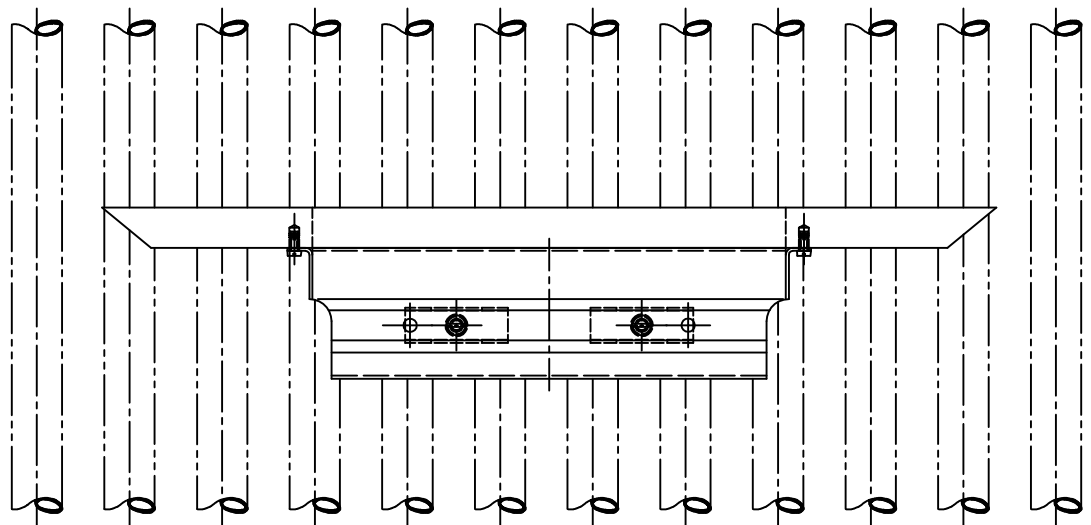

## Einzelheit M2:1

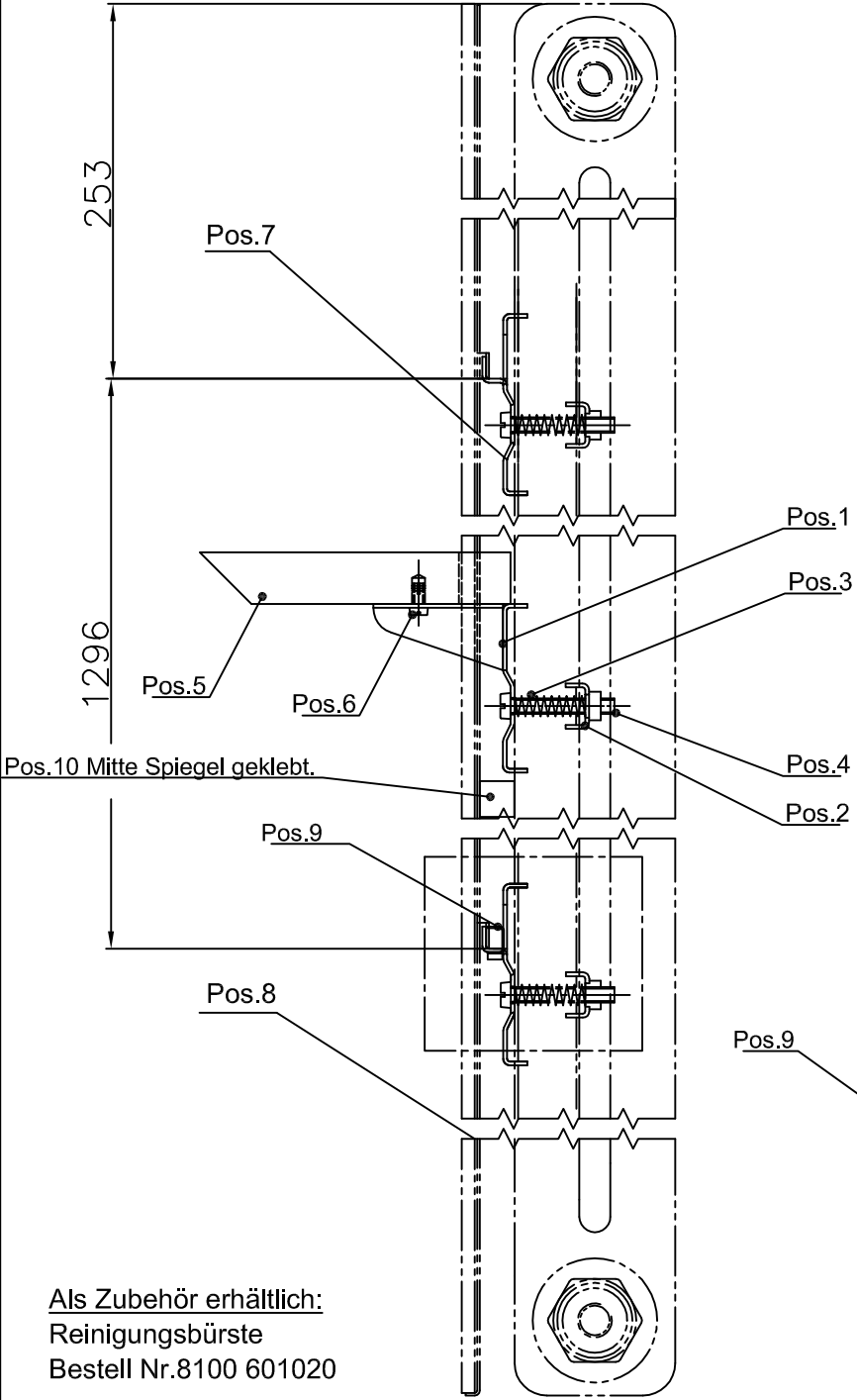
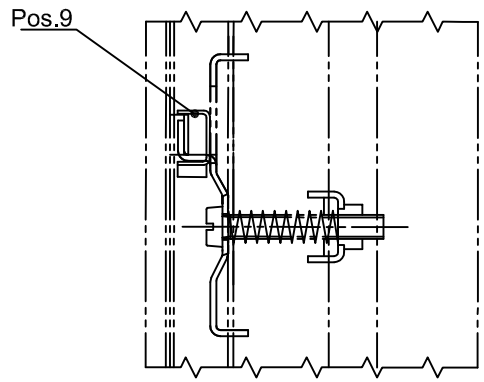

Als Zubehör erhältlich:  
Reinigungsbürste  
Bestell Nr.8100 601020

10	1	Dämpfungspuffer m. Klebefl.	
9	1	Spiegel-Sicherung	
8	1	Spiegel	
7	2	Spiegelhalterung	
6	2	Flachkopfschrb. mit Schlitz	Form A ; M4x6 DIN 85
5	1	Holzablage	
4	6	Flachkopfschrb. mit Schlitz	Form A ; M6x45 DIN 85
3	6	Druckfeder	
2	6	Klemmteil	
1	1	Ablagenhalter	
Pos.	Stck.	Benennung	Abmessung/Bemerkung

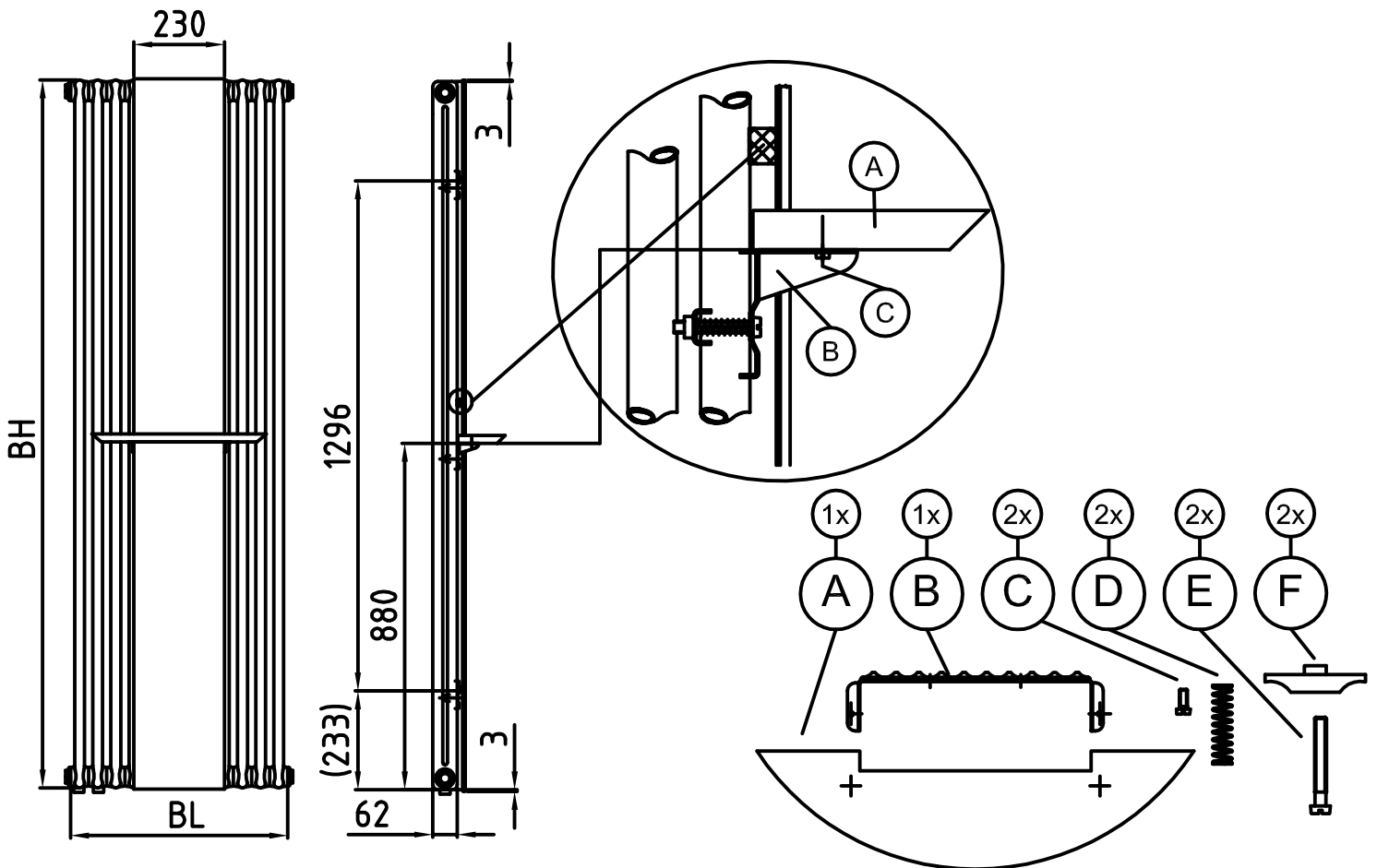

1

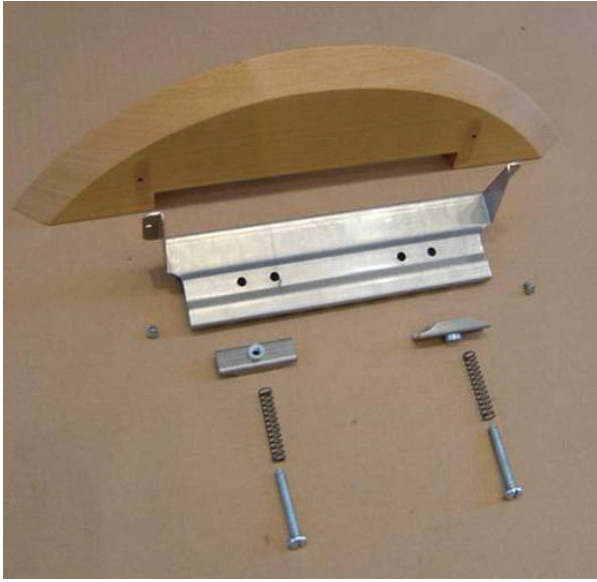

2

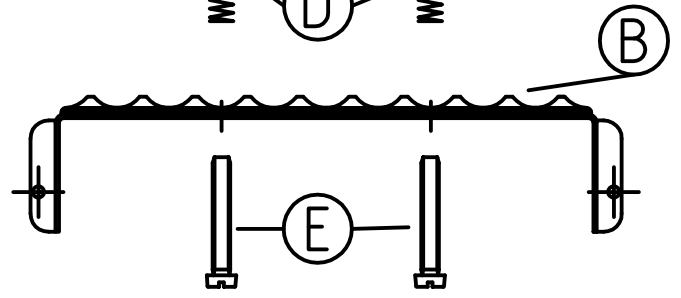
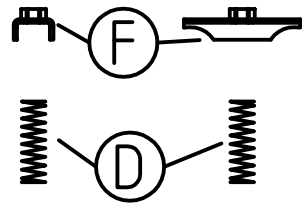

4



3

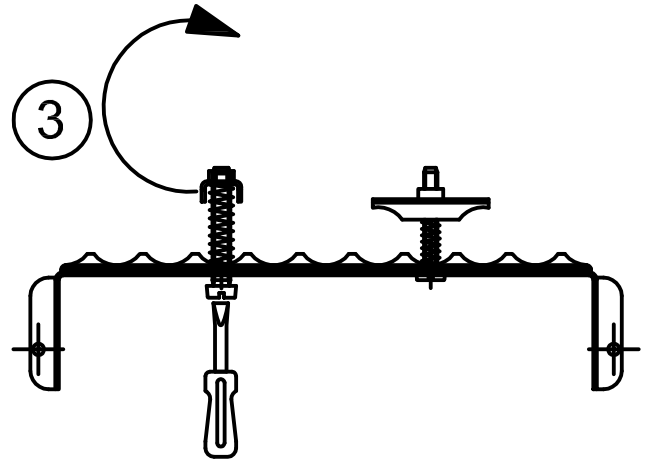

5

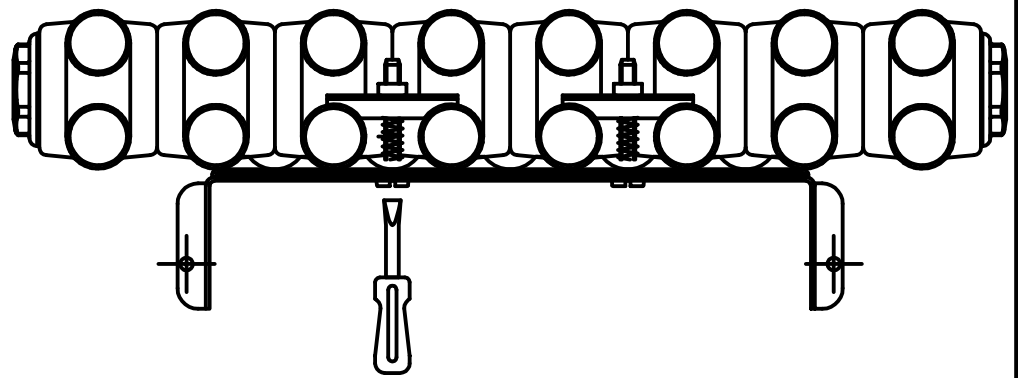

6



7

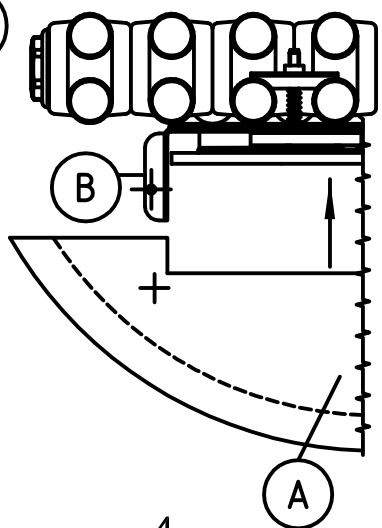

8

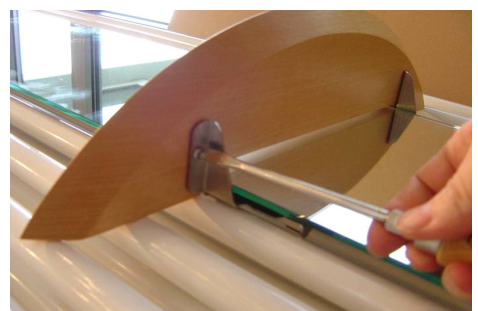

1

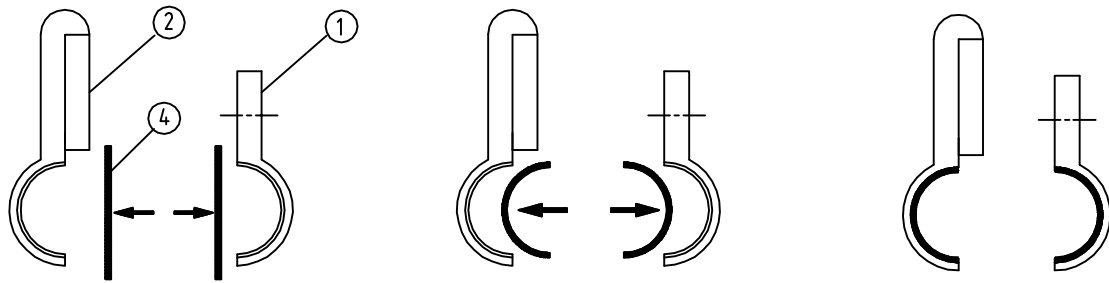

2

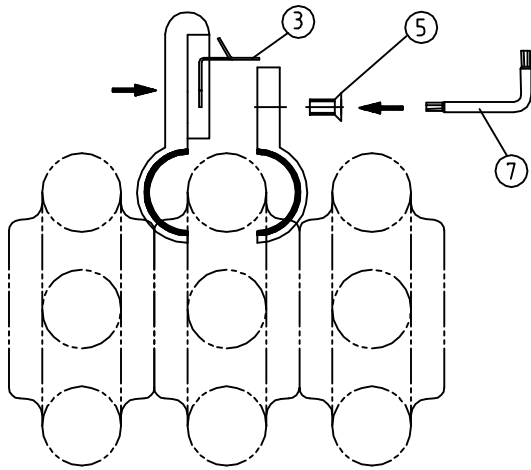

3

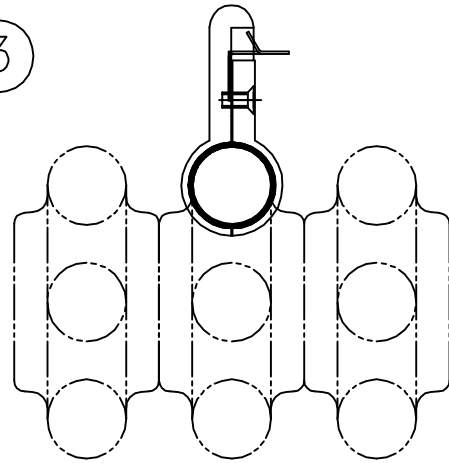

4

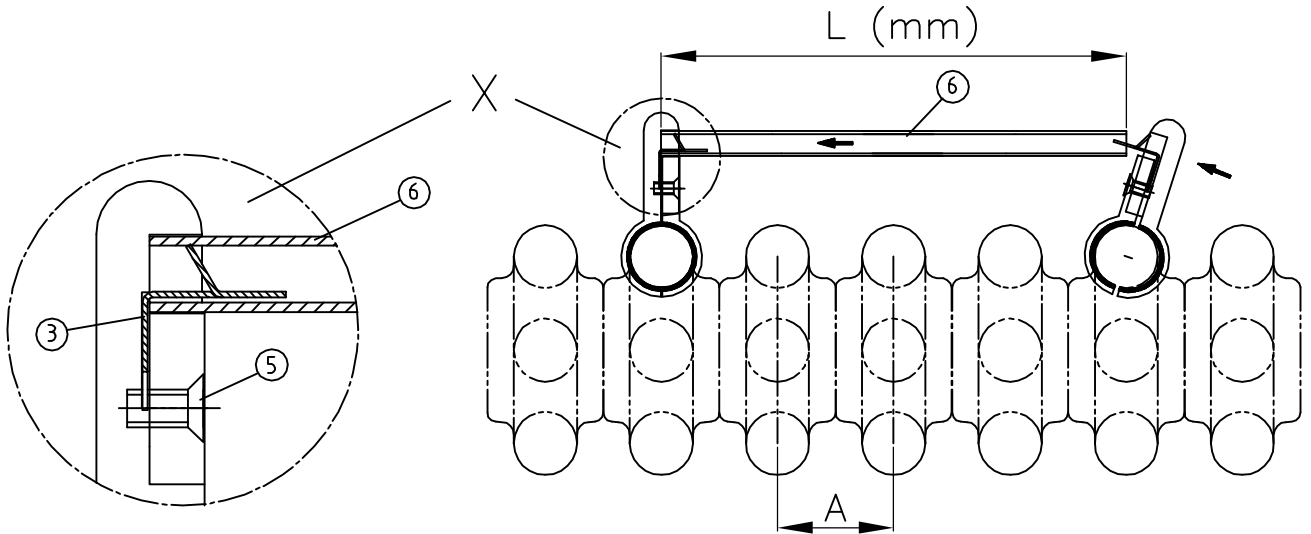

5

Beispiel / Example / Exemple / Esempio

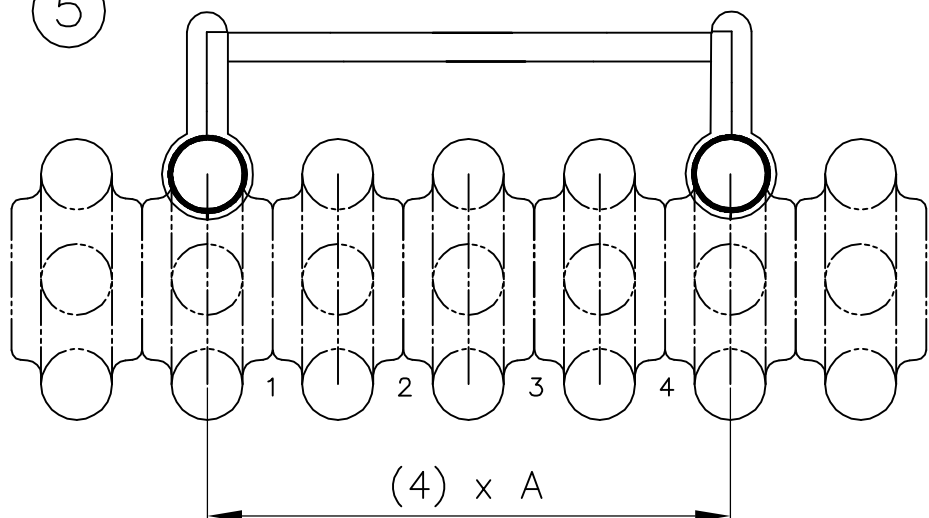

( ) x A = L	
4 x A	182
5 x A	228
6 x A	274
7 x A	320
8 x A	366
9 x A	412
10 x A	458
11 x A	504
12 x A	550
13 x A	596
14 x A	642
15 x A	688
16 x A	734
17 x A	780
18 x A	826
19 x A	872
20 x A	918

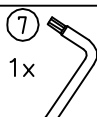
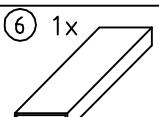
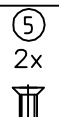
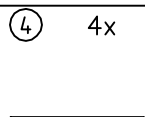
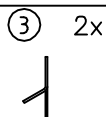
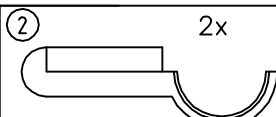
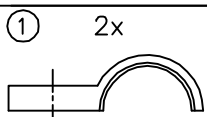

Montageanleitung  
 Mounting instruction  
 Guide de pose  
 Istruzione di montaggio