

Zehnder ComfoConnect PRO

Installer manual

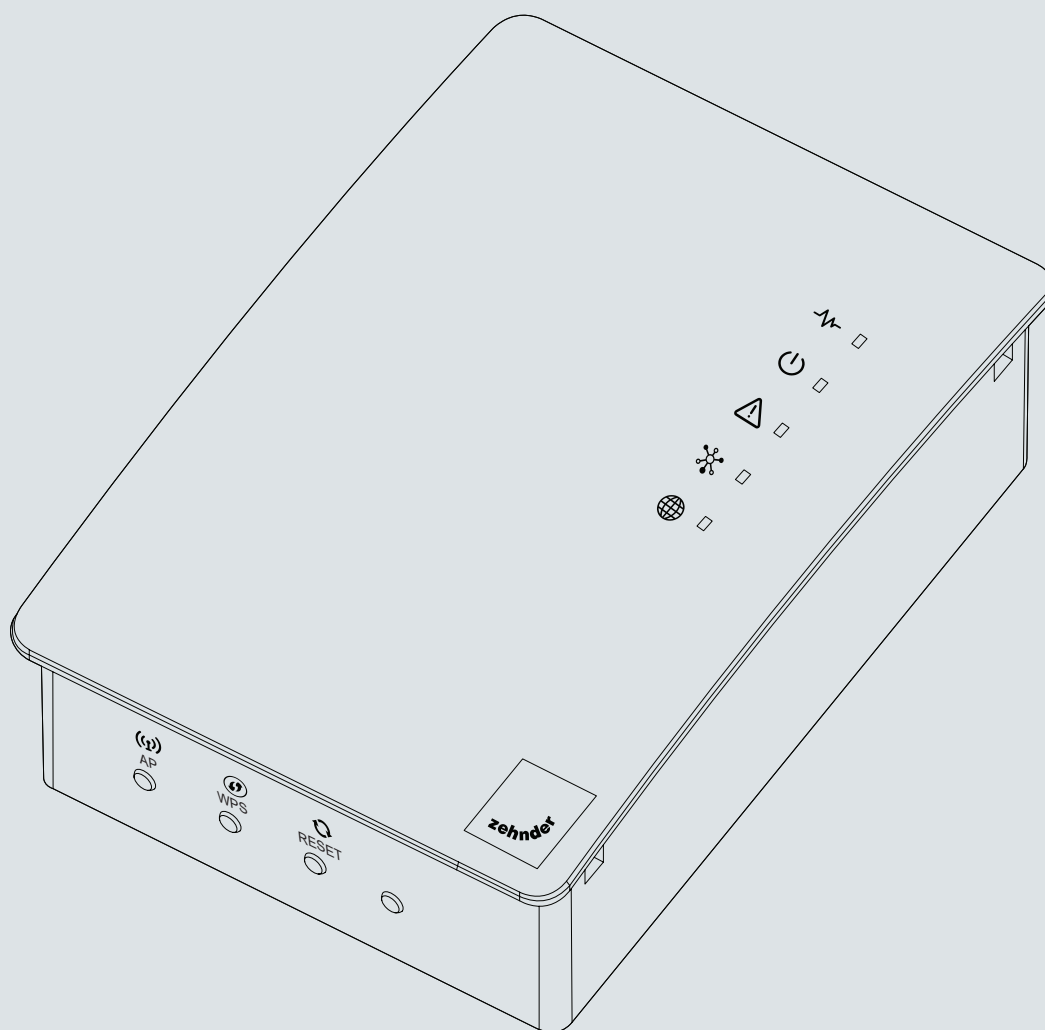

Table of Contents

Preface	3
1 Introduction	4
2 CE and UKCA declaration of conformity	4
2.1 Simplified EU declaration of conformity.....	4
2.2 Identification plate.....	4
3 Warranty	5
4 Liability	5
5 Safety	5
5.1 Safety measures.....	6
5.2 Reference directives.....	6
6 For the Installer	7
6.1 ComfoConnect PRO configuration.....	7
7 Technical specifications	8
8 ComfoConnect PRO installation	9
8.1 Installation of the ComfoConnect PRO.....	9
8.2 Installation procedures.....	10
8.3 Controls and LEDs description.....	12
8.4 ComfoConnect PRO setting.....	14
8.5 Maintenance - Service.....	18
9 Third-part communication protocols	18
9.1 Modbus TCP.....	18
9.2 Modbus RTU.....	19
9.3 ComfoAirQ/Flex exposed interface.....	21
9.4 ComfoAirQ/Flex Request Examples.....	24
9.5 ComfoAirQ alarm codes.....	26
10 Waste disposal	28
11 Connecting diagram	29
12 Contacts	29

All rights reserved.

This manual has been compiled with the utmost care. The publisher cannot be held liable for any damage caused as a result of missing or incorrect information in this manual.

Preface



IMPORTANT!
Carefully read this manual before use.

This manual provides all the information required for a safe and optimal installation and maintenance of the ComfoConnect PRO. It is also intended as a reference for servicing, so that this can be carried out in a responsible manner. The device is subject to continuous development and improvement. As a result, the ComfoConnect PRO may slightly differ from the descriptions.



NOTE : this manual has been compiled with the utmost care. However, no rights can be derived from it. In addition, we at all times reserve the right to change the contents of this manual, without prior notice.

The following pictograms are used in this document:

Symbol	Meaning
	Consult the manual before using/operate the equipment.
	Point of attention / important informations.
	Risk of compromised performance or damage to the ventilation system / risk of personal injury.
	Caution electrical hazard.

Use the QR code to access all documents, including the CE- UKCA declaration.



More info and
regulation to UK
law PSTI.

1 Introduction

The ComfoConnect PRO is a new modular gateway designed to be compatible with all Zehnder ventilation systems connected to the domestic local area network.



2 CE and UKCA declaration of conformity

2.1 Simplified EU declaration of conformity

The full text of EU declaration of conformity is available on Zehnder website.

2.2 Identification plate

The ComfoConnect PRO has a CE and UKCA marking on the identification plate. The identification plate can be found on the bottom side of the device.











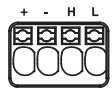

Model: ComfoConnect PRO Power Input: 12 V $\overline{=}$ 0.5 A
Product Number: 30006323 Power Consumption: 6 W

WiFi SSID: ComfoConnectPro
Password: *
<http://comfoconnectpro.local>

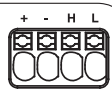
Designed by Zehnder Group Italia S.r.l.
Via G. di Vittorio, 6 • 41011 Campogalliano (MO) • Italy
Made in Italy

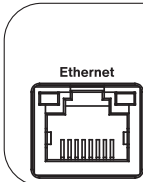
CAN_H → H
CAN_L → L
12 Vdc → +
GND → -







CAUTION!

It is strictly prohibited to remove the identification plate and/or replace it with other plates. Should the plate be damaged, detached or removed for accidental reasons, the customer must inform the supplier.

3 Warranty

The ComfoConnect PRO is covered by the manufacturer's warranty for a period of 24 months from the delivery date. Warranty claims may only be submitted for material faults and/or construction faults arising during the warranty period.

The warranty becomes invalid if:

- the warranty period has expired;
- installation of the device was not carried out in accordance with the proper instructions;
- defects have occurred due to incorrect connection, incompetent use;
- spare parts used that were not originally supplied by the manufacturer, or repairs done by unauthorised persons.



CAUTION!

The supplier shall not be held liable for any damage, to things or people, caused by accidents due to a failure to comply with the instructions provided in this manual and in the following chapters.



The manufacturer retains the right to change and/or reconfigure its products at any time without any obligation to alter previously delivered products.

4 Liability

The ComfoConnect PRO has been designed and manufactured to be integrated in “balanced ventilation systems”. Any other use is deemed as an unintended use and can lead to damage to the ComfoConnect PRO or personal injury, for which the manufacturer cannot be held liable.

The manufacturer is not liable for any damage originating from:

- non-compliance with the safety, operating and maintenance instructions in this manual;
- the use of components not supplied or recommended by the manufacturer;
- normal wear and tear.

5 Safety



Always comply with the safety regulations, warnings, comments and instructions given in this document. Failure to comply with the safety regulations, instructions, warnings and comments may lead to personal injury or damage to the device.

5.1 Safety measures



It is the user's responsibility to apply preventive and protective measures, in accordance with the legislation of the country of installation and use of the device.



To avoid any risk of electrical shock only the type of AC/DC power adaptor indicated in this manual must be used.



Do not connect the units to the power supply until the end of the complete installation and the mutual connection of the units is done.



Only connect certified peripherals/devices to the device.



Operations on the device must be carried out by specialized and authorized personnel only.



Always disconnect the electrical power supply before carrying out any work on the device.



Check that the electrical voltage meets the values indicated in this manual before connecting the device. Only the connections indicated in this manual to expected equipments are allowed.



Disconnect the device from any power source before cleaning.



The enclosure of the device must be cleaned only with a dry cloth.



Do not install this apparatus near water (e.g. near washbasins, sinks, showers, bathtubs, swimming pool, wet floors or anything in the presence of water and liquids in general).



Keep the device away from exposure to moisture values outside the admissible range indicated in this manual.



The device must always be fixed to a machine before proceeding with any type of operation and/or use.



It is strictly forbidden to modify the appliance in order not to compromise the characteristics relating to the declared requirements.



Make sure that any part of the device cannot come in contact with an unconscious, anaesthetized or incapacitated patient.



It is strictly forbidden to cover the device during operation.



Personnel training is a responsibility of the manufacturer of the device to which the ComfoConnect PRO will be connected.

5.2 Reference directives

Zehnder Group International places the device on the market, equipping and providing it with:

- CE marking as IT device;
- Simplified EU declaration of conformity;
- Installer manual.

Please also note that the device has been designed according to the following Directives:

- 2011/65/EU (RoHS);
- 2014/53/EU RED.

6 For the Installer

6.1 ComfoConnect PRO configuration

The standard ComfoConnect PRO configuration consists of:

- 1 ComfoConnect PRO device;
- 1 ComfoNet data cable;
- 1 quick user guide;
- 1 kit for wall fastening (with screws).

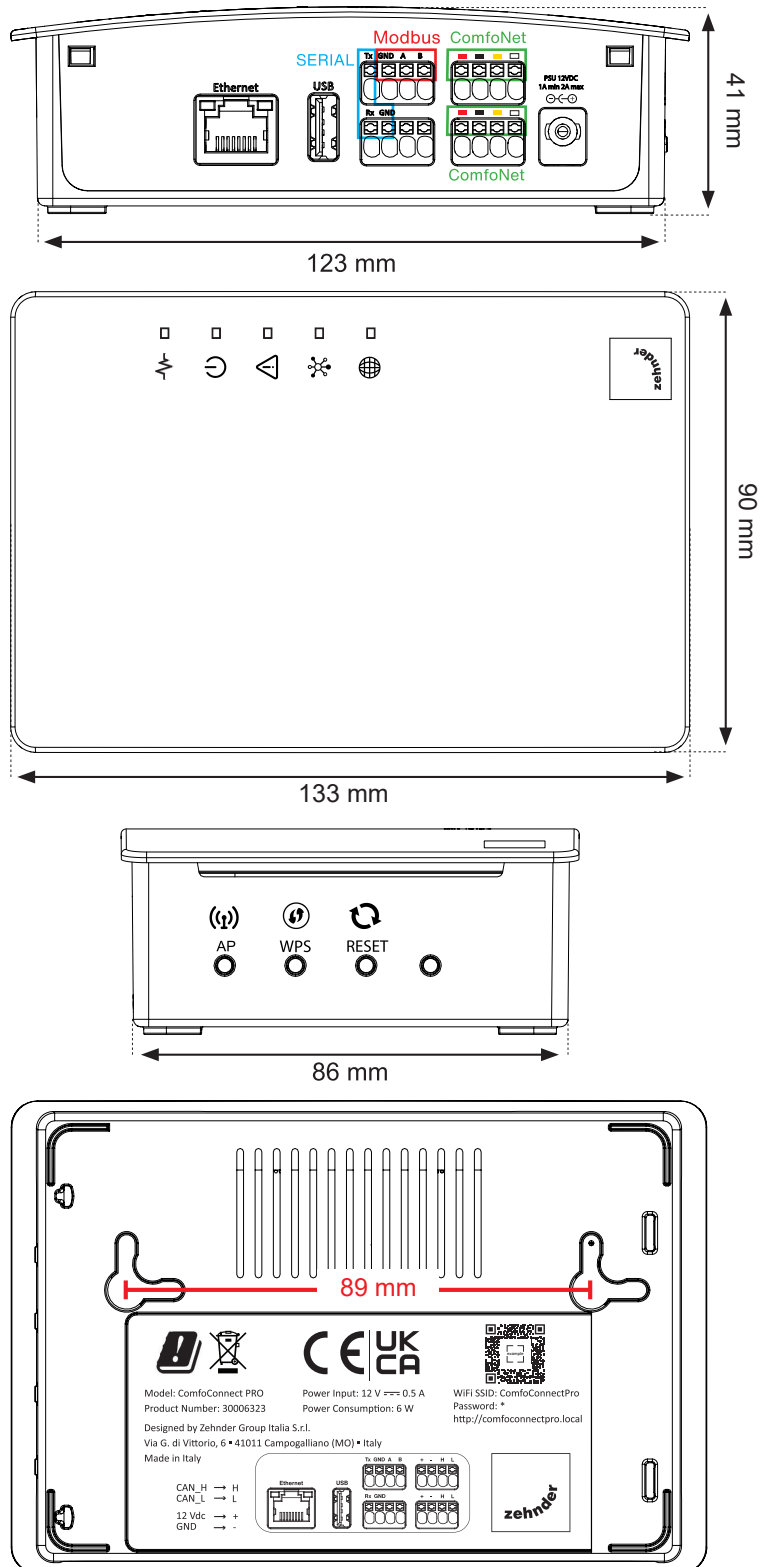

7 Technical specifications

Product Data	
Name	ComfoConnect PRO
Number	30006323
Electrical	
Nominal input voltage	+12VDC
Nominal input current	max 2Amp
Nominal power consumption	1,7 W / Max 6 W (Only if USB port in use)
Environmental	
Operating temperature	-5 °C to +35 °C
Storage temperature	-5 °C to +35 °C
Humidity	< 95% (non-condensing)
Flammability rating of connectors	UL 94 V-0
Flammability rating of housing	UL 94 V-0
Flammability rating of PCB	UL 94 V-0
Housing material	Plastic
Standards	
Directives and Certification requirements	RED 2014/53/EU EN 62368-1 :2020 +A11: 2020 EN IEC 62311 :2020 ETSI EN 301 489-1 V.2.2.3 ETSI EN 301 489-17 V.3.2.4 ETSI EN 300 328 v.2.2.2 RoHS
Electrical connection	
ComfoConnect PRO connection	Color Codes (cable and connection)
CAN_L	WHITE
CAN_H	YELLOW
GROUND	BLACK
12V	RED
Network connection	
Wi-Fi	2,4GHz / 5GHz
Ethernet	10/100 Mbit
Connectors	RS 232 / RS485
Power supply	
Rated voltage	230VAC 50Hz (main power by AC/DC Converter) 12 VDC 2Amp by ZEHNDER auxiliary device.  Use only in combination with external AC/DC adapter, certified according to IEC/EN 62368-1, providing 12 VDC output (ES1/PS2 type), internally protected against both output overload and short-circuit, with 2 A max. available current.
EMI Requirements	To be compliant to Class "B" emission of EN 55032, when AD/DC adaptor is used, additional Würth ferrite mod 742 711 42 (or equivalent) and must be inserted near to the VDC plug connector.

8 ComfoConnect PRO installation

In order to determine whether the ComfoConnect PRO can be installed in a certain area, the following aspects must be taken into account:

- the device must be installed in a frost-free space;
- the device must be mounted only on flat, stable surface.
- the device is designed for use in residential areas only. The device is not suitable for commercial use such as in swimming pools or saunas. Installation in an industrial environment can damage the device;
- the allowed temperature of the installation area is provided in the section “Technical specifications”;
- check whether the electrical installation can fulfil the maximum capacity of the device. The maximum capacity is provided in the section “Technical specifications”.

8.1 Installation of the ComfoConnect PRO

8.1.1 Unpacking



Contact your supplier immediately in case of damage or incomplete delivery and do not proceed with the installation.

- Take the necessary precautions when unpacking the ComfoConnect PRO device.
- Keep it upright when unpacking it.

8.1.2 Checking the delivery

The delivery should include:

- the ComfoConnect PRO device;

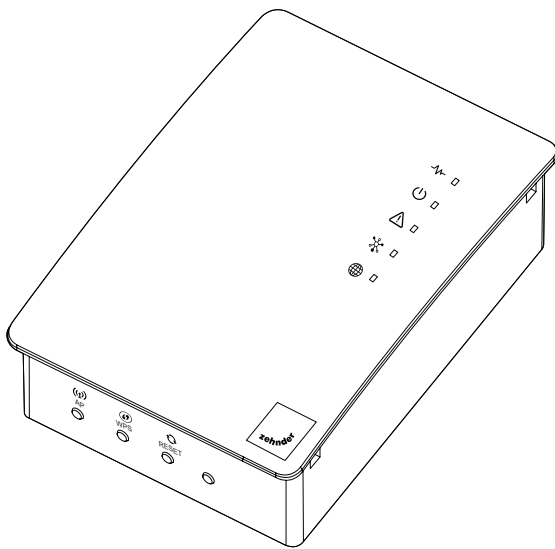

Check the identification plate to ensure that you have received the correct device type.

- Wall fastening kit (with screws);

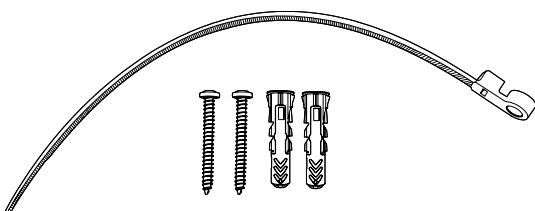

- 1 ComfoNet data cable.

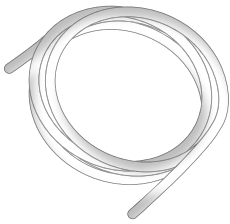

8.2 Installation procedures



CAUTION!
Do not connect the units to any power supply (be it an internal or external).

To install the device properly on **wall**, follow the procedure below:

Step	Action
1	Make sure the electric connection is off and the electric power supply is disconnected from the device.
2	Proceed to fasten the device to the destination area, using the relative screws in points (A), indicated in the figure.
3	Proceed to connect the electric supply to the device.

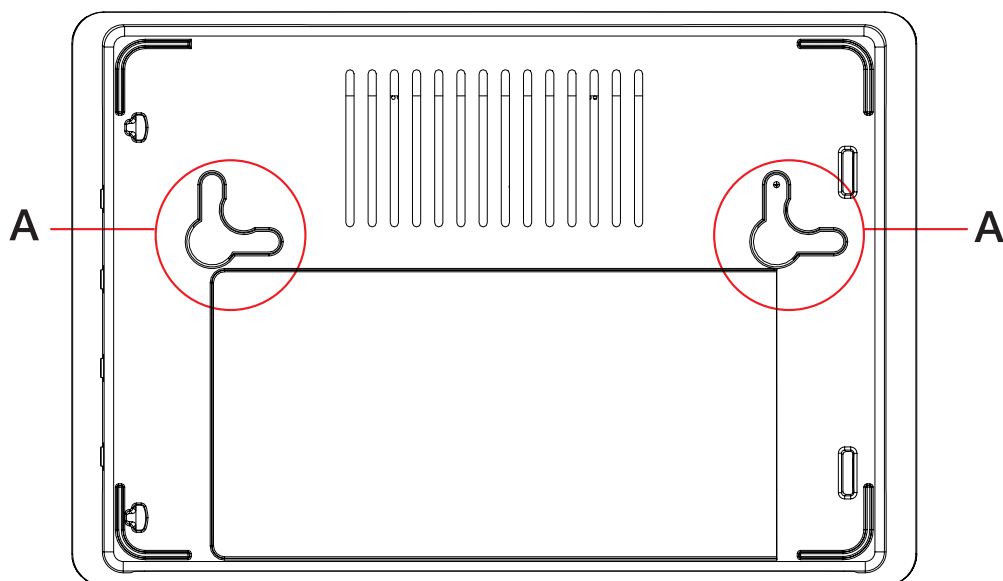

The device can be wall installed in vertical or horizontal way.

To install the device properly on **table/plane surface**, follow the procedure below:

Step	Action
1	Make sure the electric connection is off and the electric power supply is disconnected from the device.
2	Proceed positioning the device taking care to leave enough space around and that the support fit feet (B) have enough grip on the surface.
3	Proceed to connect the electric supply to the device.

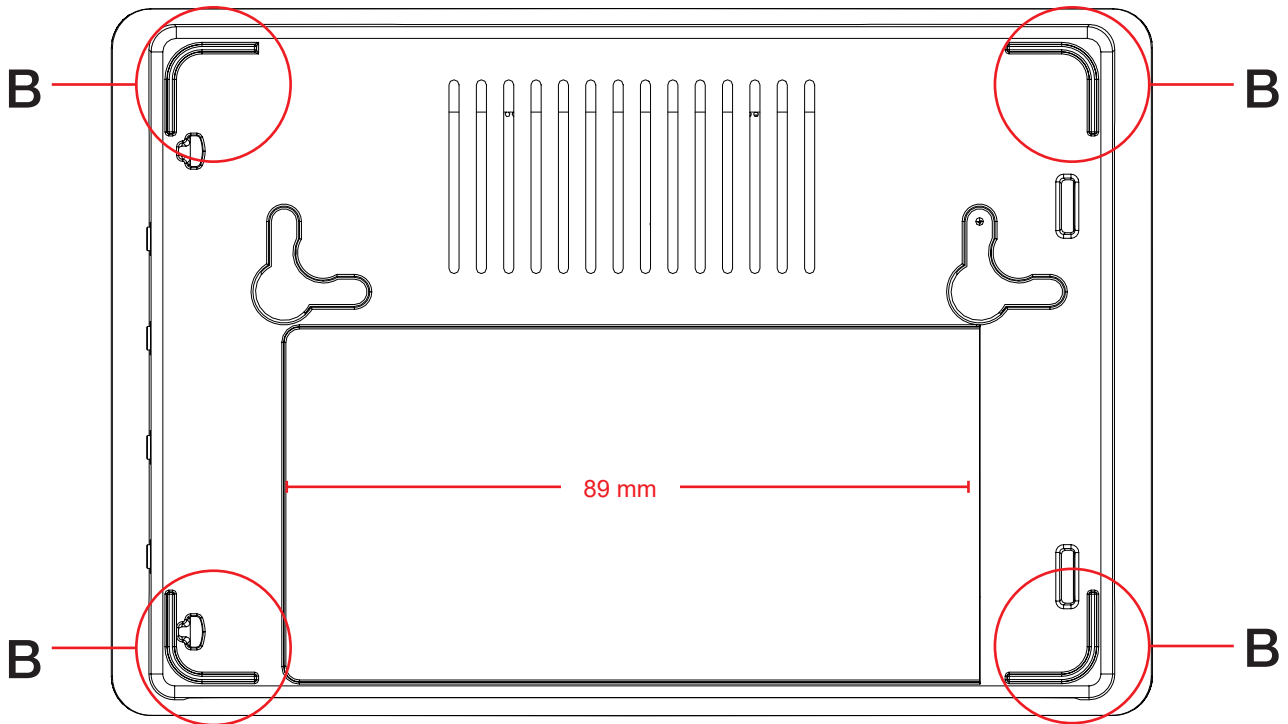

CAUTION!









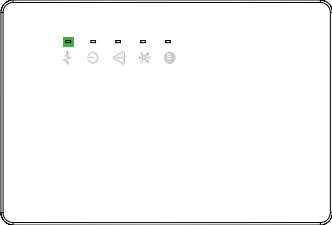

In case of malfunctioning such as weird noise or bad smell, unplug the power supply and call a Zehnder Authorised Representative.

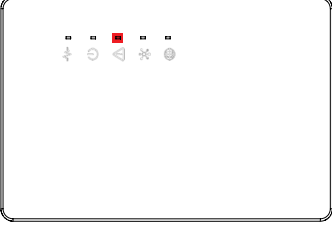

Always comply with the safety regulations, warnings, comments and instructions given in this document. Failure to comply with the safety regulations, instructions, warnings and comments may lead to personal injury or damage to the device.

8.3 Controls and LEDs description

On the front cover, five different LEDs indicating the actual working mode of the device are visible. Led and icon meaning are explained in the following table:

Led/Icon	Meaning
 	<ul style="list-style-type: none"> ▪ ACTIVITY LED - Green Slowly blinks to signal that the system is up and running.
 	<ul style="list-style-type: none"> ▪ POWER LED - Green It is lit if the ComfoConnectPro is powered.
 	<ul style="list-style-type: none"> ▪ ALARM LED - Red Starts during the startup phase then turns off and will only blink in case of application errors.
 	<ul style="list-style-type: none"> ▪ ComfoNet LED - Green Starts blinking during the access phase then stays lit if the communication is fine. It blinks in case of ComfoNet errors (for example cable issues or a device issue)
 	<ul style="list-style-type: none"> ▪ INTERNET LED It is green if the internet access is ok. It is blue if Access Point (Direct-Access) is enabled. It is purple if WPS is enabled. It turns red if there's no internet access.

On the side cover of the device there are four buttons that have different functions.
The functions of each button are:

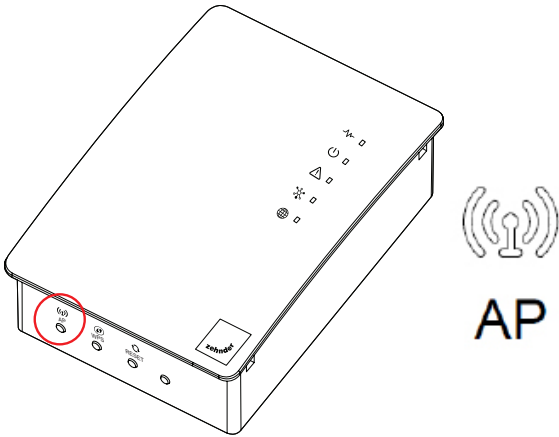
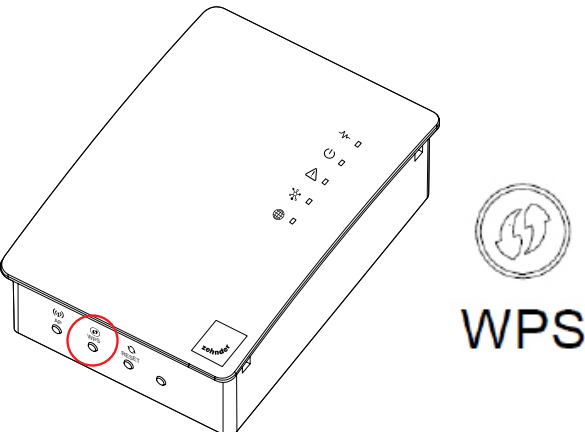
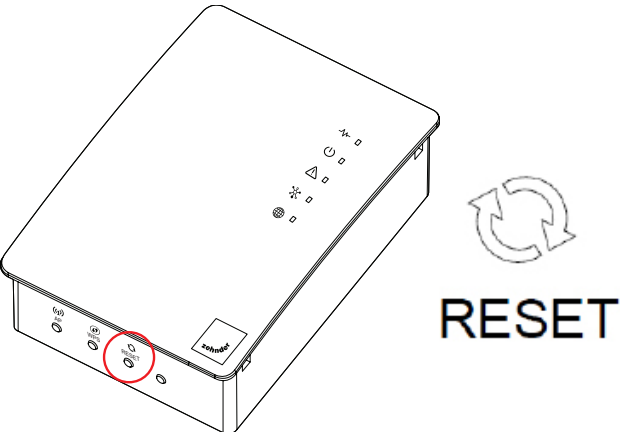
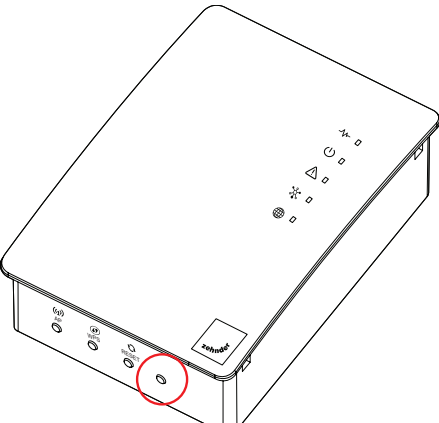
Button	Function
	<ul style="list-style-type: none"> ▪ AP (ACCESS POINT) button <p>By enabling Access Point mode, a new and temporary wireless network is created, named “ComfoConnectPro”. Connect to this network, enter the password located on the gateway’s label to configure the ComfoConnect PRO through a simple and easy web interface. Open a browser and connect to the address http://comfoconnectpro.local (or http://10.1.1.1 if the previous address doesn’t work).</p> <p>If AP is enabled, the “Internet” LED becomes Blue.</p>
	<ul style="list-style-type: none"> ▪ WPS button <p>You can easily add ComfoConnect PRO to the home Wi-Fi using the WPS button: by pressing it once and enabling WPS functionality on the router, it should be enough to automatically connect ComfoConnect PRO without having to enter any network password. When WPS is enabled, Internet LED turns Purple.</p>
	<ul style="list-style-type: none"> ▪ RESET button <p>It is possible to reset ComfoConnect PRO by pressing and holding the reset button for 3 seconds (alarm LED will start blinking). Pressing and holding the reset button for 10 seconds will instead initiate a factory reset (all LED will turn off).</p>
	<ul style="list-style-type: none"> ▪ Reserved for future use. Currently does nothing.

8.4 ComfoConnect PRO setting

After installation, the ComfoConnect PRO device must be configured.
Proceed with the device activation by cables according to the following steps:

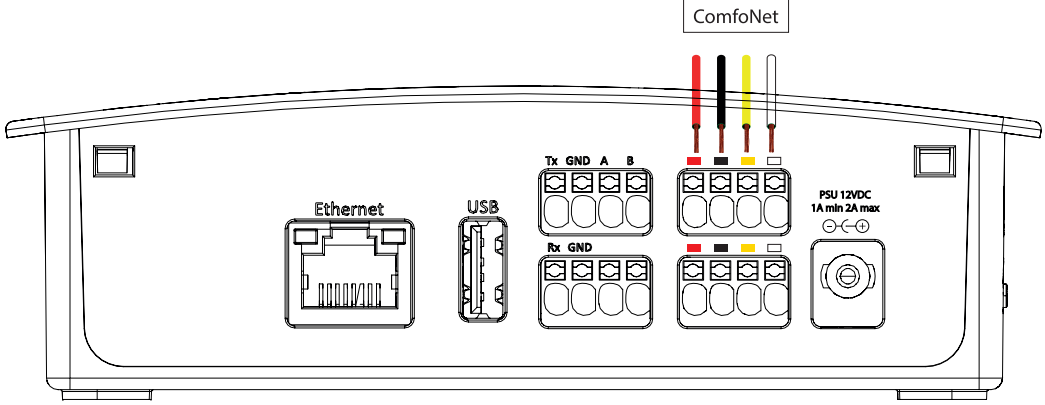
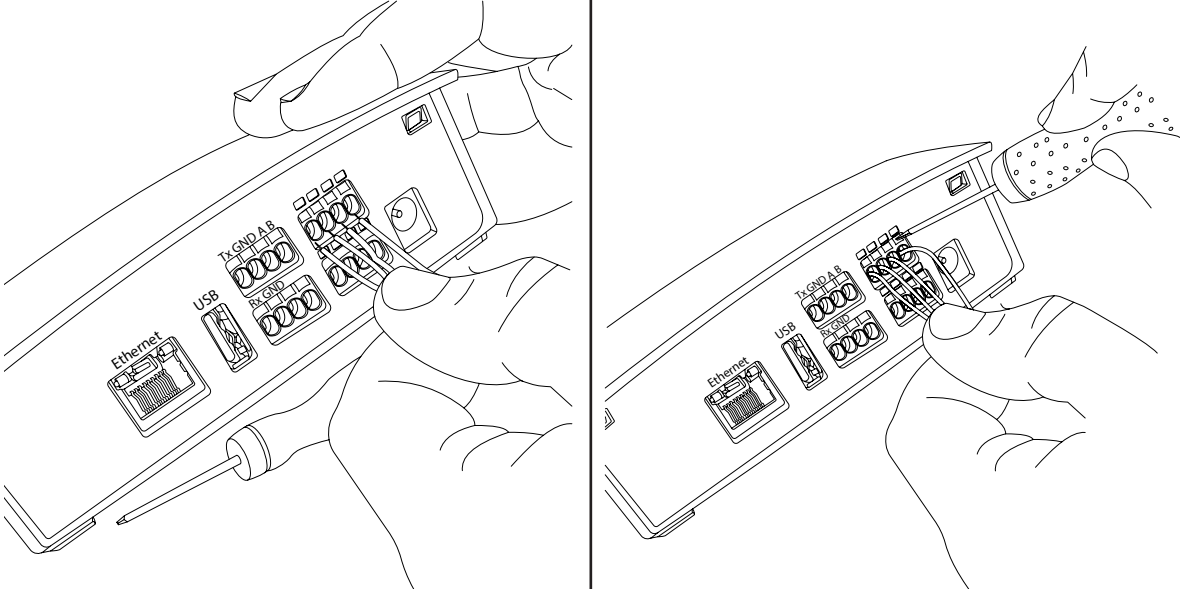
Step	Action
1	<p data-bbox="240 331 933 360">Connect the device to the cables as illustrated in the picture.</p>  <p data-bbox="240 842 1477 931">Place the cables in the correct color sequence as shown in illustration. Using a screwdriver of the appropriate size, press the designated buttons above each connector slot to release the spring and allow the cable to enter. Release the pressure on the button. Repeat the same procedure for the remaining cables.</p> 
2	<p data-bbox="240 1608 1458 1697">On the upper front part of the ComfoConnect PRO, the Alarm LED will turn red and the Power LED will turn green to indicate correct installation and functioning. The RED Alarm red should then turn off after some seconds.</p>



Always comply with the safety regulations, warnings, comments and instructions given in this document. Failure to comply with the safety regulations, instructions, warnings and comments may lead to personal injury or damage to the device.

8.4.1 ComfoConnect PRO network connection

First setup: connecting ComfoConnect PRO to your network (wired or wireless).

▪ Ethernet LAN wired connection

Just plug a RJ45 cable directly from your router (or switch) to the ComfoConnect PRO. The “Internet” LED should become green if the ComfoConnect PRO gets connected to internet or will stay red if your network is isolated. Once the ethernet cable is connected, the gateway is ready to use.

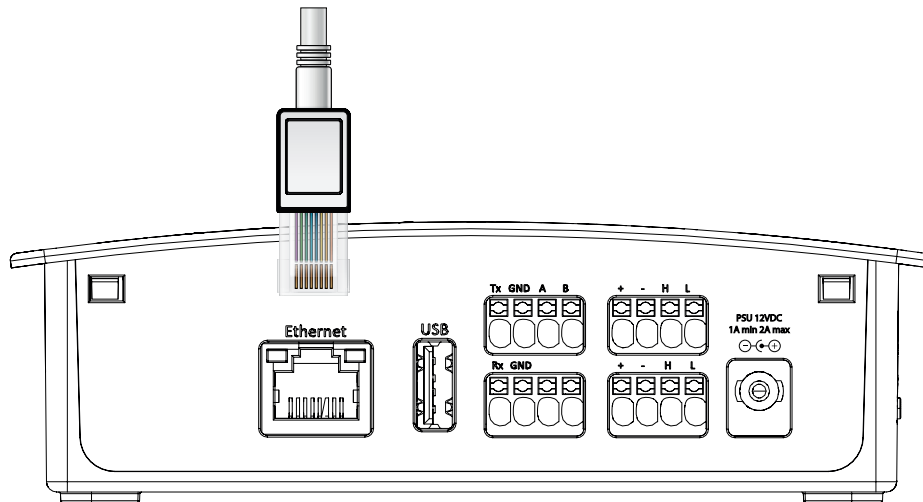

▪ Wi-Fi wireless connection

To initiate the setup of your new gateway, you will first need to connect your device (such as a smartphone or a laptop) to the gateway’s dedicated local access point. This initial step is essential for configuring your gateway to join your home Wi-Fi network.

Follow the steps below to connect and set up your gateway:

Laptop procedure

Locate the Network:

- Scan for available Wi-Fi networks on your device.
- You will identify the gateway’s local access point named “ComfoConnectPro”.
- This unique network is specifically created for the initial configuration of your gateway.

Connect to the Local Access Point:

- Select “ComfoConnectPro” from the list of available networks.
- When prompted for a password, enter the password located on the gateway’s label.



Smartphone procedure

- Scan the QR code located on the label under the device.
- After scanning the QR code, the phone automatically connects to the gateway’s network without the need to enter any password.

▪ **First Configuration**

To configure the device connection follow the procedure below:

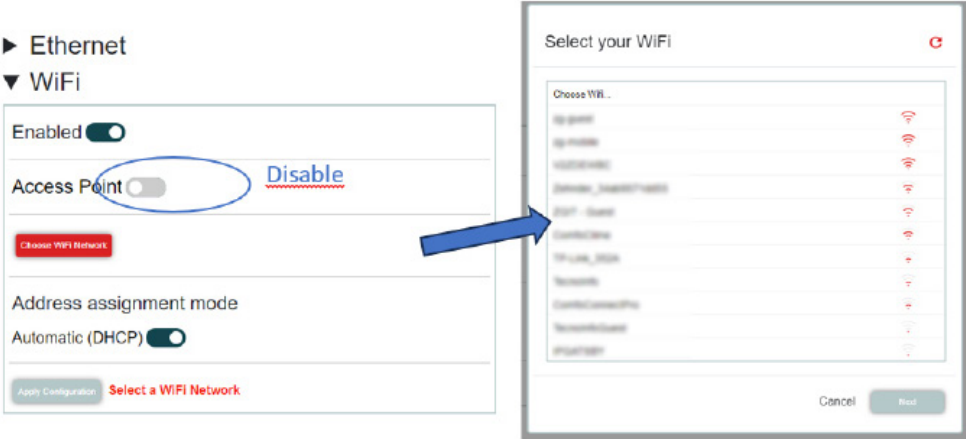
Step	Action
1	Open a browser and type the address http://comfoconnectpro.local (or http://10.1.1.1 if the previous address is not working)
2	<p>At the first configuration you will be asked to set a password. This is the password to access the gateway's configuration panel.</p> <div data-bbox="461 477 1259 831"><h3 style="text-align: center;">Set Password</h3><div style="border: 1px solid #ccc; padding: 10px;"><p>New Password <input type="password"/></p><p>Confirm Password <input type="password"/></p><p style="text-align: center;">Set Password</p></div></div>
3	<p>Then login using the password just set.</p> <div data-bbox="277 999 991 1319"><h3 style="text-align: center;">Login</h3><div style="border: 1px solid #ccc; padding: 10px;"><p>Username <input type="text" value="admin"/></p><p>Password <input type="password"/></p><p style="text-align: center;">Login</p></div></div>
4	<p>Select Network from the top menu, you will enter the network configuration page. Open WiFi section and DISABLE "Access Point" using the relative switch.</p> <div data-bbox="272 1514 873 2036"><h3 style="text-align: center;">Network Settings</h3><p>▶ Ethernet</p><p>▼ WiFi</p><div style="border: 1px solid #ccc; padding: 10px;"><p>Enabled <input checked="" type="checkbox"/></p><hr/><p>Access Point <input checked="" type="checkbox"/> Access Point name: ComfoConnectPro</p><hr/><p>Status IP: 10.1.1.1 Netmask: 255.255.255.0</p><p style="text-align: center;">Apply Configuration</p></div></div>

Step	Action
5	<p>Once disabled “Access Point”, you will have to choose the Wi-Fi network to connect to. A pop-up window with the list of available networks will appear.</p> <p>Network Settings</p> <p>► Ethernet ▼ WiFi</p> <p>Enabled <input checked="" type="checkbox"/></p> <p>Access Point <input type="checkbox"/> Disable</p> <p>Choose WiFi Network</p> <p>Address assignment mode Automatic (DHCP) <input checked="" type="checkbox"/></p> <p>Apply Configuration Select a WiFi Network</p> 
6	<p>After selecting a network, enter the password to access it.</p> 
7	<p>To confirm the configuration press then “Apply Configuration”. ComfoConnect PRO will restart and will connect to your network. The “Internet” LED should become green if the ComfoConnect PRO gets connected to internet or will stay red if your network is isolated. If the Network page states that you are connected to your Wi-Fi it means that you are connected to the local Wi-Fi with no internet access so cloud/remote functions will not work, if it doesn’t stat that you are connected you should retry the procedure.</p> <p>Network Settings</p> <p>► Ethernet ▼ WiFi</p> <p>Enabled <input checked="" type="checkbox"/></p> <p>Access Point <input type="checkbox"/></p> <p>Choose WiFi Network</p> <p>Selected network: ComfoClimate</p> <p>Address assignment mode Automatic (DHCP) <input checked="" type="checkbox"/></p> <p>Apply Configuration Press Apply Configuration to apply the changes</p>



Always comply with the safety regulations, warnings, comments and instructions given in this document. Failure to comply with the safety regulations, instructions, warnings and comments may lead to personal injury or damage to the device.

8.5 Maintenance - Service

The ComfoConnect PRO doesn't require any ordinary maintenance activity.
Only a general cleaning as removing the dust from the ComfoConnect PRO with a dry duster.



WARNING!

Before every operation over the device please disconnect the electric power from all devices.



CAUTION!

For others maintenance operations please refer to the Service manual. Only Zehnder authorised personnel should open on the unit.

9 Third-part communication protocols

In the "Protocols & Services" page you can select the protocol you intend to use for the integration.

Options are **None** – **Modbus TCP** – **Modbus RTU**. Different selection displays different options.

9.1 Modbus TCP

After installation, the ComfoConnect PRO device must be configured.

When Modbus TCP is selected, the IP address of the client is the one displayed in the Network page: it will be shown in the ethernet section if ComfoConnect PRO is connected to the network via ethernet, in the Wi-Fi section otherwise.

The default slave ID is 1 but it can be modified in the value range 1 to 247 in case ID 1 is already assigned.

The default TCP port used is 502 and shouldn't be changed normally, as 502 is the port defined by the Modbus standard.

Zehnder ComfoConnectPro v0.41.10 Home Network Configurations zehnder

Third Party Settings

3rd Party Protocols
ModbusTCP

Slave Id
1

TCP Port
502

Save

WARNING: Saving will REBOOT your ComfoConnectPro



Always comply with the safety regulations, warnings, comments and instructions given in this document. Failure to comply with the safety regulations, instructions, warnings and comments may lead to personal injury or damage to the device.

9.2 Modbus RTU

Proceed with the device activation by cables according to the following steps:

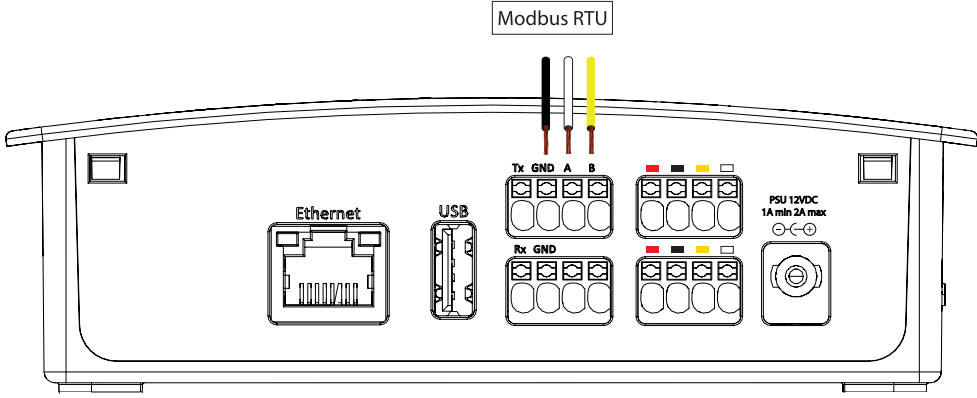
Step	Action
1	Connect the device to the cables as illustrated in the picture. 



Always comply with the safety regulations, warnings, comments and instructions given in this document. Failure to comply with the safety regulations, instructions, warnings and comments may lead to personal injury or damage to the device.

When Modbus RTU is selected, the following options are available.

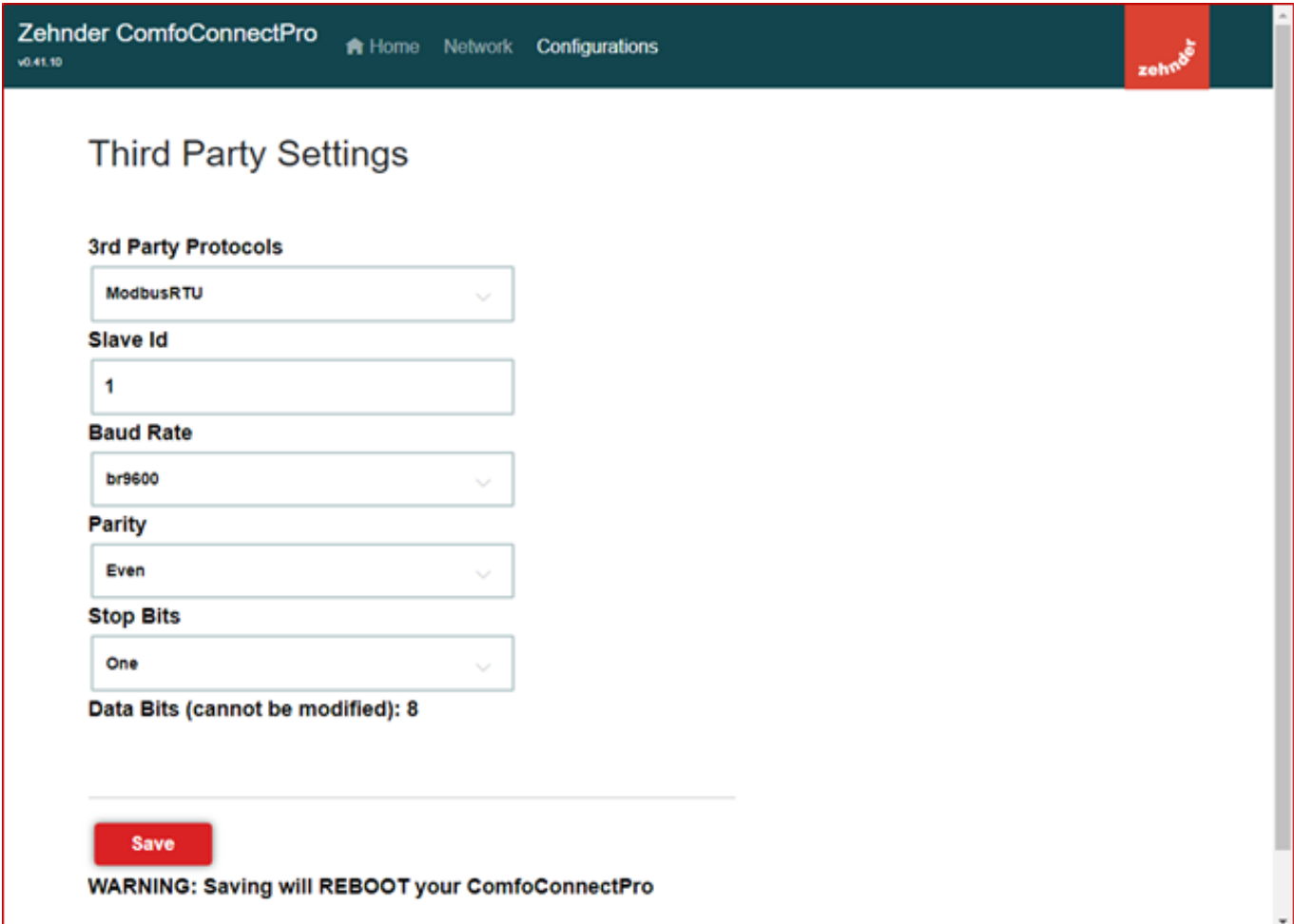

Zehnder ComfoConnectPro v0.41.10 Home Network Configurations zehnder

Third Party Settings

3rd Party Protocols
ModbusRTU

Slave Id
1

Baud Rate
br9600

Parity
Even

Stop Bits
One

Data Bits (cannot be modified): 8

Save

WARNING: Saving will REBOOT your ComfoConnectPro

Just like on Modbus TCP, the default slave ID is 1 but it can be modified in the value range 1 to 247 in case ID 1 is already assigned.

Baud rate, data bits, parity, start bits and stop bits must match the settings used by the master serial port.

Available baud rates:

9600, 14400, 19200, 28800, 38400, 57600, 115200, 128000, 230400, 256000, 460800 and 921600.

Data bits are always 8, start bit is always 1.

Even parity is standard but also None and Odd can be configured.

If Even or Odd parity is selected, 1 stop bit must be configured.

If no parity is selected, 2 stop bits must be configured.



Always comply with the safety regulations, warnings, comments and instructions given in this document. Failure to comply with the safety regulations, instructions, warnings and comments may lead to personal injury or damage to the device.

9.3 ComfoAirQ/Flex exposed interface

Table	Address	Variable	Units	Access	Data Type	Note
discrete inputs	0x0001	Error flag		R	bool	
input registers	0x0001	Connection State		R	byte	0: ok 30: the detected ventilation unit is not a CAQ 40: CAQ version not compatible 50: no ventilation unit detected
input registers	0x0002	ActiveError1		R	byte	
input registers	0x0003	ActiveError2		R	byte	
input registers	0x0004	ActiveError3		R	byte	
input registers	0x0005	ActiveError4		R	byte	
input registers	0x0006	ActiveError5		R	byte	
coils	0x0001	Reset errors		R/W	bool	self-resetting coil, value false is ignored
holding registers	0x0001	Ventilation Preset		R/W	byte (0-3)	
coils	0x0002	Ventilation Preset Away		R/W	bool	value false is ignored
coils	0x0003	VentilationPreset1		R/W	bool	value false is ignored
coils	0x0004	VentilationPreset2		R/W	bool	value false is ignored
coils	0x0005	VentilationPreset3		R/W	bool	value false is ignored
coils	0x0006	Auto Mode		R/W	bool	
holding registers	0x0002	Temperature Profile		R/W	byte (0 normal, 1 cold, 2 warm)	works only in mode 0 or 1
holding registers	0x0003	Temperature Profile Mode		R/W	byte (0 adaptive, 1 fixed, 2 external setpoint)	
holding registers	0x0004	External Setpoint	°C*10	R/W	ushort	works only in mode 2
coils	0x0007	Boost		R/W	bool	
holding registers	0x0005	Boost time	s	R/W	ushort	65535 is considered 24 hours
coils	0x0008	Away function		R/W	bool	
coils	0x0009	ComfoCool		R/W	bool	
discrete inputs	0x0002	Standby		R	bool	
discrete inputs	0x0003	ComfoHood		R	bool	

input registers	0x0007	Airflow	mch	R	ushort
input registers	0x0008	Room temperature	°C*10	R	short
input registers	0x0009	Extract temperature	°C*10	R	short
input registers	0x000A	Exhaust temperature	°C*10	R	short
input registers	0x000B	Outdoor temperature	°C*10	R	short
input registers	0x000C	Supply temperature	°C*10	R	short
input registers	0x000D	Room humidity	%	R	byte
input registers	0x000E	Extract humidity	%	R	byte
input registers	0x000F	Exhaust humidity	%	R	byte
input registers	0x0010	Outdoor humidity	%	R	byte
input registers	0x0011	Supply humidity	%	R	byte
input registers	0x0012	CO2 sensor zone 1	ppm	R	ushort
input registers	0x0013	CO2 sensor zone 2	ppm	R	ushort
input registers	0x0014	CO2 sensor zone 3	ppm	R	ushort
input registers	0x0015	CO2 sensor zone 4	ppm	R	ushort
input registers	0x0016	CO2 sensor zone 5	ppm	R	ushort
input registers	0x0017	CO2 sensor zone 6	ppm	R	ushort
input registers	0x0018	CO2 sensor zone 7	ppm	R	ushort
input registers	0x0019	CO2 sensor zone 8	ppm	R	ushort
input registers	0x001A	Filter days remaining	days	R	warning
discrete inputs	0x0004	Filter dirty		R	alarm

Implemented function codes are:

FC	meaning
1	ReadCoils
2	ReadDiscreteInputs
3	ReadHoldingRegisters
4	ReadInputRegister
5	WriteSingleCoil
6	WriteSingleRegister
15	WriteMultipleCoils
16	WriteMultipleRegisters

Used data tables are:

Table	Size	Access
Discrete inputs	1 bit	Read only
Coils	1 bit	Read/write
Input registers	16 bits	Read-only
Holding registers	16 bits	Read/write

Implemented exception codes are:

Code	Meaning
1	InvalidFunctionCode
2	InvalidDataAddress
3	InvalidDataValue
4	SlaveDeviceFailure
5	Acknowledge
6	SlaveDeviceBusy
7	NegativeAcknowledge
8	MemoryParityError
10	GatewayPathUnavailable
11	GatewayTargetDeviceFailedToRespond

Remember that, as per Modbus standard, in the PDU registers and coils are addressed starting at zero. For example, registers numbered 1-16 are addressed as 0-15.

9.4 ComfoAirQ/Flex Request Examples

9.4.1 Modbus TCP

Read alarm flag

MBAP header				Function code	Starting address	Quantity
Transaction identifier	Protocol identifier	Length	Unit identifier			
2 bytes	2 bytes	2 bytes	1 byte	1 byte	2 bytes	2 bytes
0x1234	0x0000	0x0006	0x01	0x02	0x0000	0x0001

```
>> 12 34 00 00 00 06 01 02 00 00 00 01
```

Response (flag active)

MBAP header				Function code	Byte count Ceil(qty)	Values
Transaction identifier	Protocol identifier	Length	Unit identifier			
2 bytes	2 bytes	2 bytes	1 byte	1 byte	1 byte	1 byte
0x1234	0x0000	0x0004	0x01	0x02	0x01	0x01

```
<< 12 34 00 00 00 04 01 02 00 01 00 01
```

Error response (gateway path unavailable)

MBAP header				Error code	Exception code
Transaction identifier	Protocol identifier	Length	Unit identifier		
2 bytes	2 bytes	2 bytes	1 byte	1 byte	1 byte
0x1234	0x0000	0x0004	0x01	0x82	0x0A

```
<< 12 34 00 00 00 04 01 82 0A
```

9.4.2 Modbus RTU

Active preset 3 (high flow)

Unit identifier	Function code	Address	Value	CRC
1 byte	1 byte	2 bytes	2 bytes	2 bytes
0x01	0x05	0x0004	0xFF00	0xCDFB

```
>> 01 05 00 04 FF 00 CD FB
```

Response

Unit identifier	Function code	Address	Value	CRC
1 byte	1 byte	2 bytes	2 bytes	2 bytes
0x01	0x05	0x0004	0xFF00	0xCDFB

```
<< 01 05 00 04 FF 00 CD FB
```

Read alarm flag

MBAP header				Function code	Starting address	Quantity
Transaction identifier	Protocol identifier	Length	Unit identifier			
2 bytes	2 bytes	2 bytes	1 byte	1 byte	2 bytes	2 bytes
0x1234	0x0000	0x0006	0x01	0x02	0x0000	0x0001

>> 12 34 00 00 00 06 01 02 00 00 00 01

9.5 ComfoAirQ alarm codes

The codes are referred to the Modbus input registers named **ActiveError1**, **ActiveError2**, ... **ActiveError5**

Num	Code	Description
21	HRU_T_FIRE_ERR	Two or more temperature sensors are out of boundaries
22	T_HRU_ERR	Temperature too high for HRU
23	T_11_ERR	Temperature sensor T11 value exceeded limit too often
24	T_11_LIMIT_ERR	Temperature sensor T11 value exceeds limit
25	T_12_ERR	Temperature sensor T12 value exceeded limit too often
26	T_12_LIMIT_ERR	Temperature sensor T12 value exceeds limit
27	T_20_ERR	Temperature sensor T20 value exceeded limit too often
28	T_20_LIMIT_ERR	Temperature sensor T20 value exceeds limit
29	T_21_ERR	Temperature sensor T21 value exceeded limit too often
30	T_21_LIMIT_ERR	Temperature sensor T21 value exceeds limit
31	T_22_ERR	Temperature sensor T22 value exceeded limit too often
32	T_22_LIMIT_ERR	Temperature sensor T22 value exceeds limit
33	HRU_INIT_ERR	HRU has not been initialized
34	HRU_FRONT_OPEN_ERR	The front door is open
35	H_21_release_ERR	Preheater is present, but its location (left/right) does not match the orientation of the HRU
37	H_21_P_ERR	Preheater fails to deliver requested power
38	H_21_P_ratio_ERR	Preheater fails to deliver requested power in required ratio
39	φ_11_ERR	Humidity sensor φ11 value exceeded limit too often
41	φ_12_ERR	Humidity sensor φ12 value exceeded limit too often
43	φ_20_ERR	Humidity sensor φ20 value exceeded limit too often
45	φ_21_ERR	Humidity sensor φ21 value exceeded limit too often
47	φ_22_ERR	Humidity sensor φ22 value exceeded limit too often
49	P_12_ERR	Pressure sensor P12 value exceeded limit too often
50	P_22_ERR	Pressure sensor P22 value exceeded limit too often
51	F_12_s_ERR	Speed of F12 fan exceeded limit too often
51	F_12_s_ERR	Speed of F12 fan exceeded limit too often
52	F_22_s_ERR	Speed of F22 fan exceeded limit too often
53	Ptot_12_s_ERR	Static pressure of sensor P12 exceeded limit too often
54	Ptot_22_s_ERR	Static pressure of sensor P22 exceeded limit too often
55	F_12_s_set_ERR	Failed to reach required F12 fan speed too often
55	F_12_s_set_ERR	Failed to reach required F12 fan speed too often
56	F_22_s_set_ERR	Failed to reach required F22 fan speed too often
57	Qm_12_set_ERR	Failed to reach required mass flow for F12 fan too often
58	Qm_22_set_ERR	Failed to reach required mass flow for F22 fan too often
59	T_21_set_ERR	Failed to reach required temperature too often for outdoor air after preheater
60	T_22_set_ERR	Failed to reach required temperature too often for supply air
61	T_22_frost_ERR	Supply air temperature (sensor T22) is too low too often
62	Unbalance_ERR	Unbalance occurred too often beyond tolerance levels in past period
66	Present_RF_ERR	RF Communication hardware was present, but is no longer detected
67	Present_IO_ERR	Option board was present, but is no longer detected
68	Present_H_21_ERR	Preheater was present, but is no longer detected
69	Present_H_23_ERR	Post heater was present, but is no longer detected
74	Present_Hood_ERR	Cooker hood was present, but is no longer detected
75	Present_CCOOL_ERR	Comfo Cool was present, but is no longer detected
76	Present_G_ERR	ComfoFond was present, but is no longer detected
77	Filter_alarm_flag	Filters must be replaced now

78	Filter_ext_ERR	The external filter input is high
79	Filter_warning_flag	Filters must be ordered now, because the remaining filter lifetime is limited
80	Standby_ERR	Standby is active
81	H_21_COMM_ERR	Preheater does not communicate reliably
89	T_22_MANUAL_ERR	Bypass is manual used.
90	CC_OVERHEAT_ERR	ComfoCool is overheated
91	CC_COMP_ERR	ComfoCool compressor error
92	CC_T_10_ERR	ComfoCool room temperature out of bounds
93	CC_T_13_ERR	ComfoCool compressor temperature out of bounds
94	CC_T_23_ERR	ComfoCool supply temperature out of bounds
95	T_hood_ERR	Hood temperature is too high
96	IO_hood_duty_ERR	Hood is activated
97	QM_Constraint_min_ERR	Status flag
98	H_21_qm_min_ERR	Flow too low for preheater
99	config_ERR	Configuration error
100	analysis_busy_warning	Warning that error analysis is in progress
101	ComfoNet_ERR	Error on the ComfoNet bus
102	CO2_SENS_COUNT_ERR	The number of CO2 sensors on a controller has decreased – one or more sensors are no longer detected
103	CO2_SENS_TOO_MANY_ERR	More than 8 sensors are detected in a zone
104	CO2_SENS_GENERAL_ERR	General CO2 sensor error

10 Waste disposal

The parts of the packaging that can be recycled are:

- plastic bag containing screws, plugs and clamp;
- cardboard for the box.



Electrical equipment no longer in use must not be thrown away with normal municipal waste. The substances and materials it contains must be disposed of separately in an appropriate manner.

At the end of life, the device must be disposed correctly as it is a waste of electric and electronic equipment (WEEE).

11 Connecting diagram

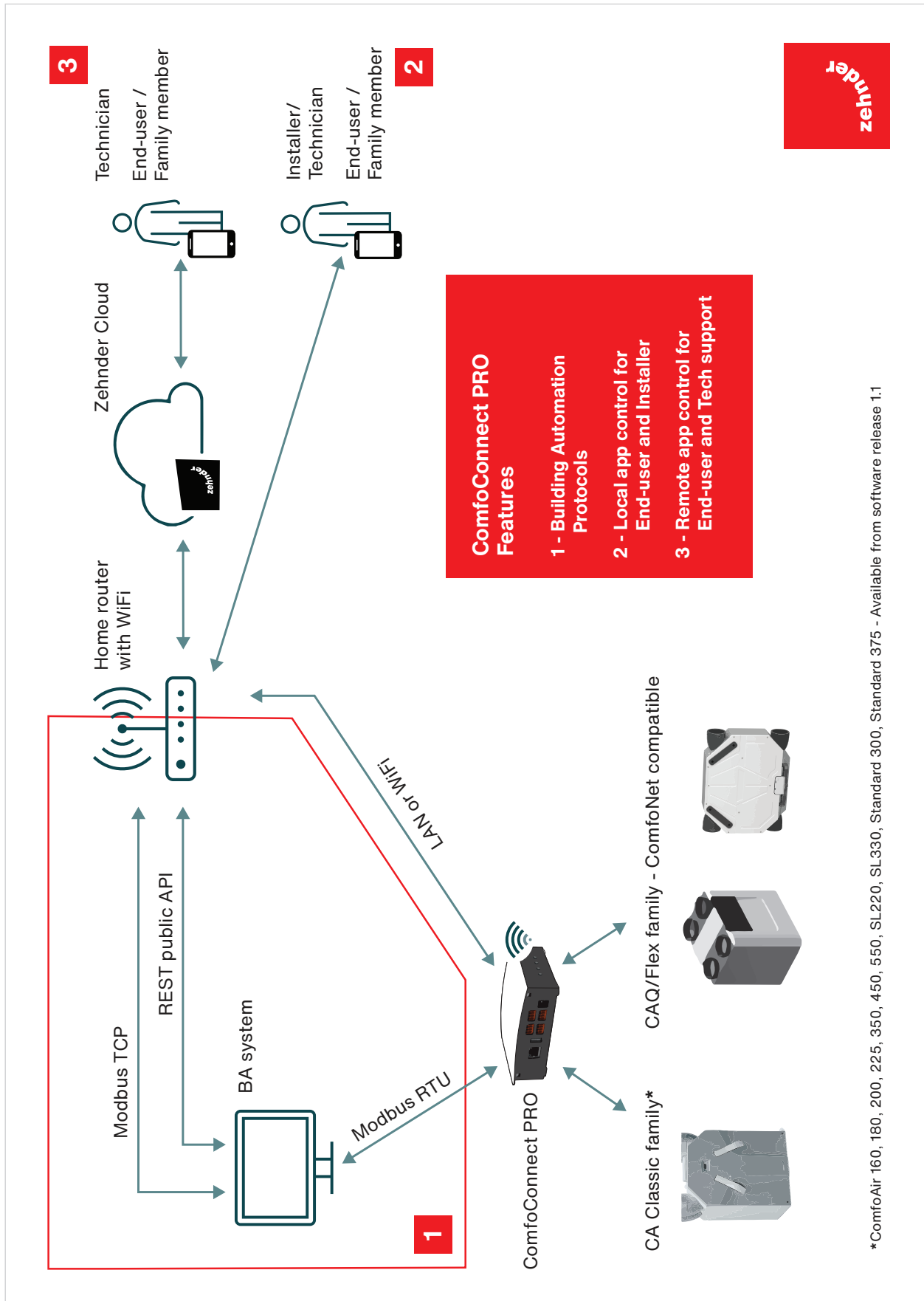

12 Contacts

For support please contact the local Zehnder Service Team.

