

zehnder

always the
best climate

Zehnder Carboline

Technical document for heating and cooling ceiling modules

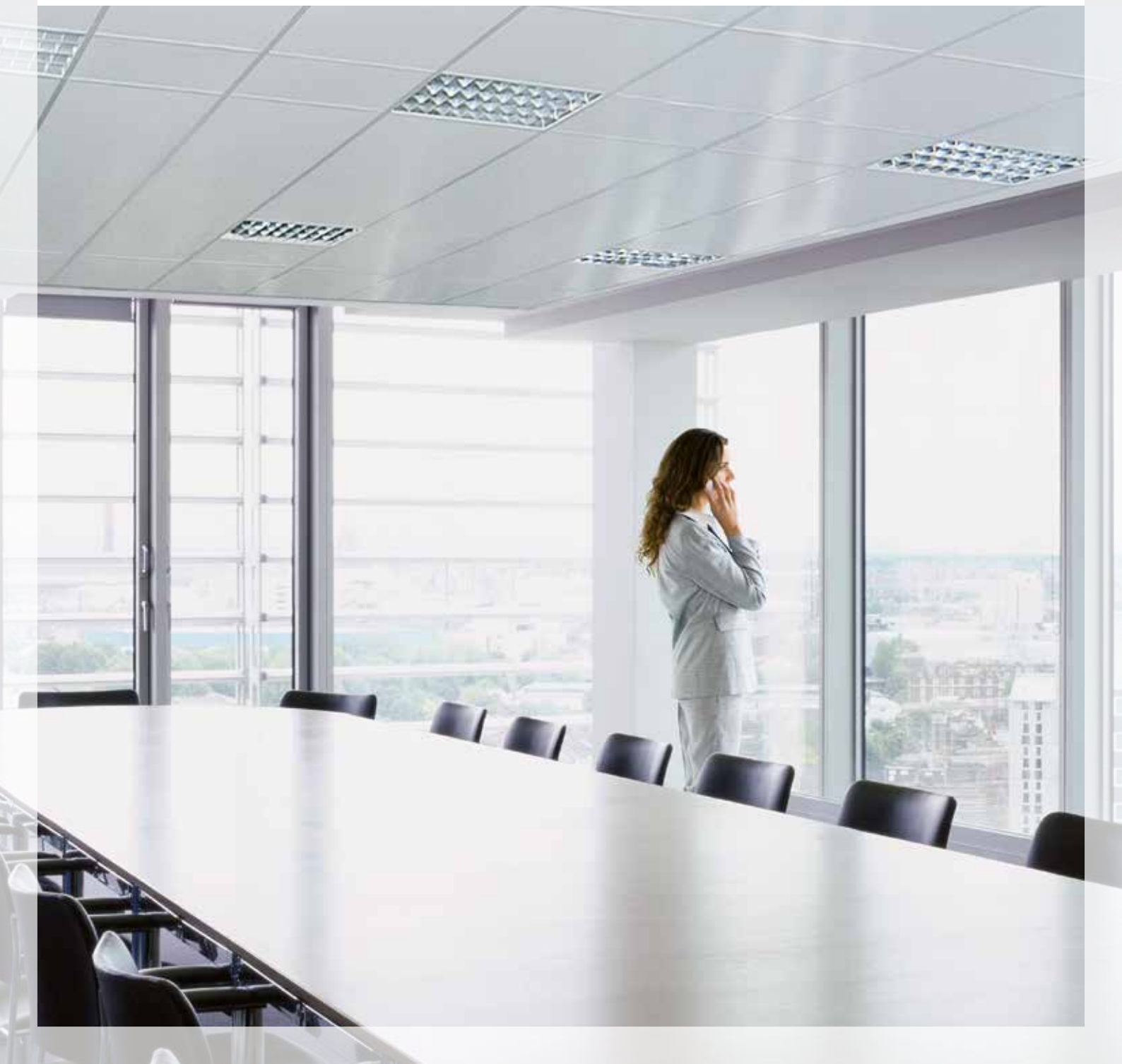

Responsive and energy efficient.

As regulations for the thermal protection of buildings become stricter, the insulation used in buildings has to keep improving. As the building fabric is so well insulated, temperatures inside rooms rise significantly during the warmer seasons of the year. This is because the high external temperatures are boosted by the interior heat load; this heat is created by computers, copiers, printers and other technical equipment – as well as the people occupying the space. As a result, the future is set to see significantly more interest in not only keeping buildings at a comfortable level of warmth, but also in creating rooms that are pleasantly cool.

Zehnder Carboline represents an elegant, innovative response to the demands placed on today's indoor climate control systems, by offering heating and cooling at an exceptionally high level of energy efficiency.

SPECIAL FEATURES OF ZEHNDER CARBOLINE

Due to expanded natural graphite, the Zehnder Carboline modules or heating and cooling ceiling elements provide optimal conditions for fast changes in temperature and energy-efficient usage once installed.

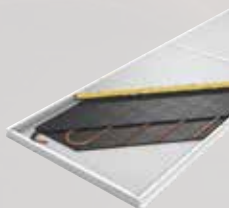

PAGE 4 – 5

MOUNTING AND INSTALLATION

Zehnder Carboline offers you numerous installation systems for closed ceilings and ceiling sails. Your specific requirements will be professionally accommodated by Zehnder's expert staff.



PAGE 6 – 15



TECHNICAL SPECIFICATIONS

- Calculation of pressure loss and minimum mass flow
- Heating and cooling performance
- Technical specification



Special features of Zehnder Carboline

Due to the advanced design, excellent response characteristics are achieved in the event of a change of temperature. Combined with the excellent performance in the field of energy efficiency and architectural freedom, Zehnder Carboline modules for heating and cooling ceiling elements provide optimal solutions in all areas of application.

Natural graphite

What distinguishes Zehnder Carboline from other modules or heating and cooling ceiling elements? One aspect is the ideal properties of the material used for the heating and cooling ceiling elements: expanded natural graphite.

Combined with Zehnder's expertise in the development and manufacture of surface heating and cooling systems, the result is a high-performance system that can be easily and practically integrated into new and existing grid ceilings.

This makes Zehnder Carboline perfectly suited to providing indoor climate control in offices, schools, hospitals, meeting rooms and surgeries – in short, everywhere that a comfortable and healthy indoor climate plays a decisive role.

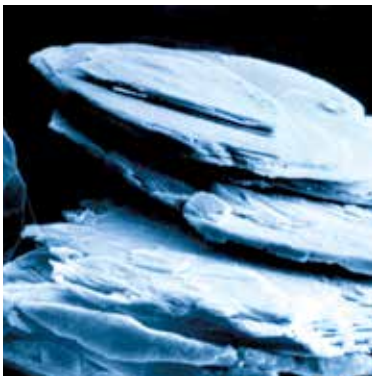

Natural graphite

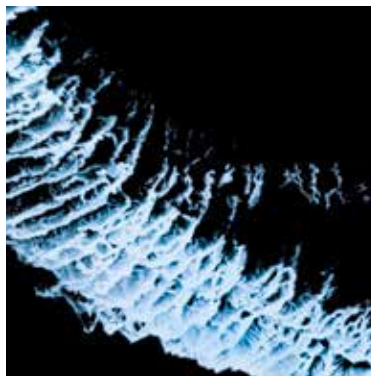

Expanded natural graphite

Expanded natural graphite: an innovative material with ideal properties

The material used for Zehnder Carboline is manufactured from scale-shaped natural graphite with a good crystalline structure.

It is a naturally occurring material and one of the inorganic modifications of carbon. The carbon atoms of the graphite are arranged in a hexagonal crystal lattice in flat, superimposed layers. The production process enlarges the volume of these parallel scales by 200 to 400 times. For Zehnder Carboline, the expanded natural graphite is then processed further into appropriately lightweight panels.

Areas of application

- Offices and meeting rooms
- Schools
- Nurseries
- Hospitals

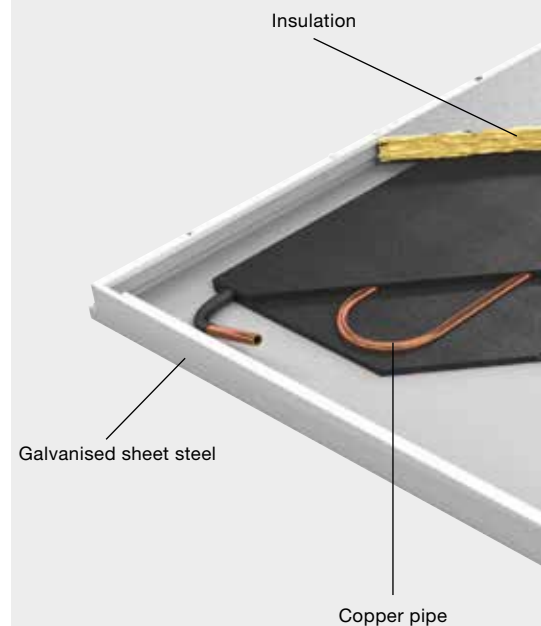

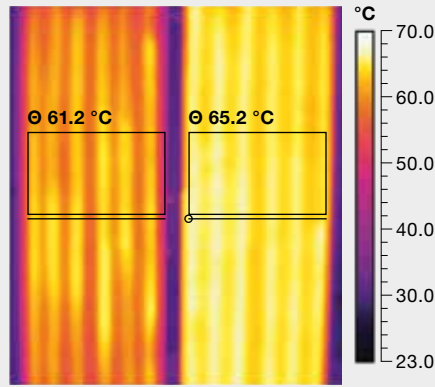

left: standard panel right: Carboline

The thermography shows the comparison between Zehnder Carboline (panel on right) and a competing product, both exposed to the same temperature and mass flow.
 Θ = average surface temperature

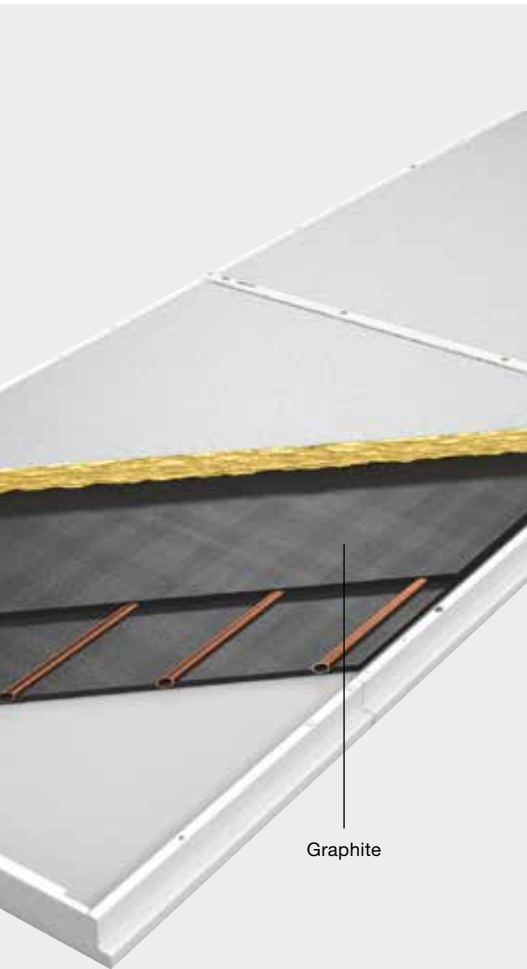

Graphite

Temperature variance across the panel width

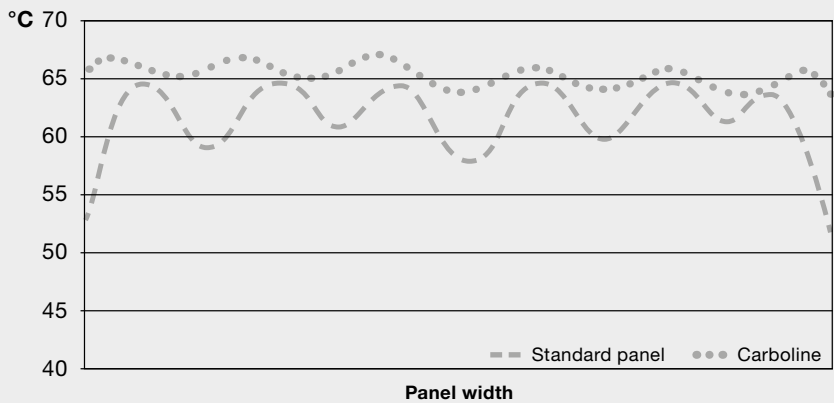

+ ADVANTAGE

- Good thermal conductivity
- Low density
- Non-flammable
- Long lifetime
- Physiologically inactive

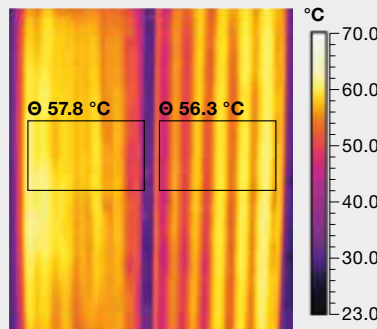

After 30 seconds
 left: standard panel right: Carboline

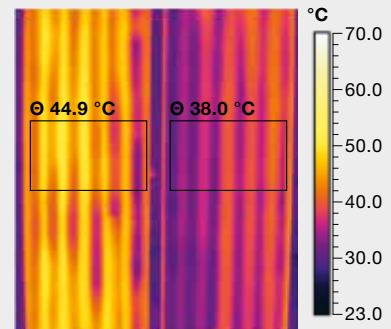

After 1 minute

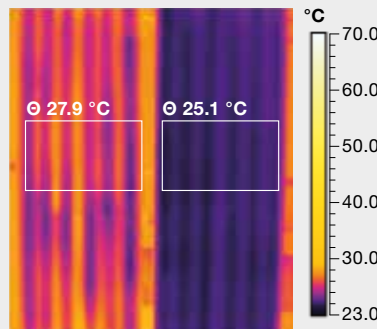

After 5 minutes

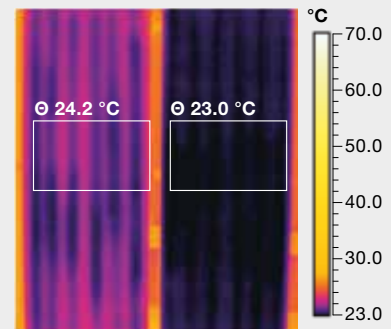

After 25 minutes

The reaction test also makes it clear that Zehnder Carboline reacts much more quickly than the competing product during a change of temperature from heating to cooling. Both systems were subjected to the same temperature and same mass flow for the test series. It can be seen that Zehnder Carboline cools much quicker and also shows better performance after 25 minutes.
 Θ = average surface temperature

Lay-in modules for closed ceilings

Zehnder Carboline is tailored for use in new or existing lay-in ceilings. The available basic grid dimensions are 600 mm and 625 mm. The lay-in modules come in two standard widths and in five standard lengths. The length of the various lay-in modules is based on the basic grid dimension and can be up to five times the basic grid dimension.

The use of longer modules can reduce the cost of installation by up to 80% compared to conventional systems available on the market. The special side construction makes it possible to insert the modules easily into the lay-in ceilings.

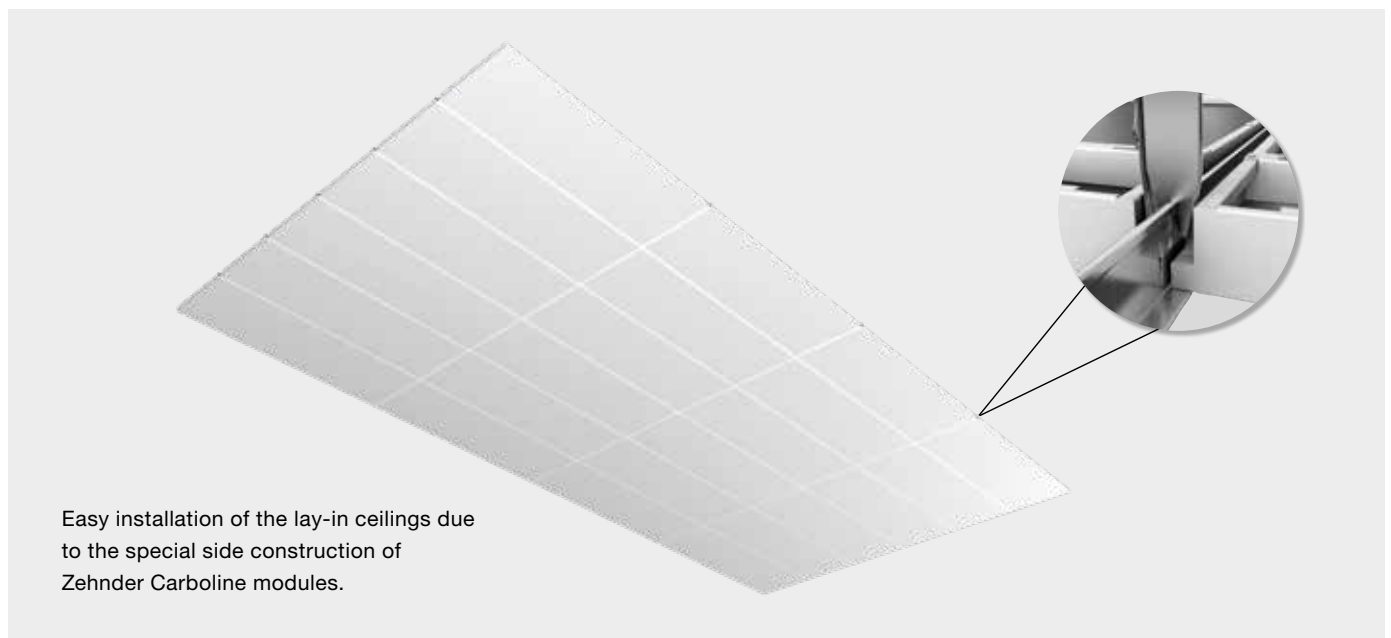

Anti-flec technology for lay-in modules

For use with lay-in modules in high temperatures and other applications.

The Zehnder Carboline lay-in modules for grid ceilings are produced from a length of 1,500 mm with anti-flec technology. This ensures an even contact surface on the ceiling grid, even when heating. After laying the modules in the grid, the anti-flec profiles are loosened in the ceiling grid by opening the screw pairs.

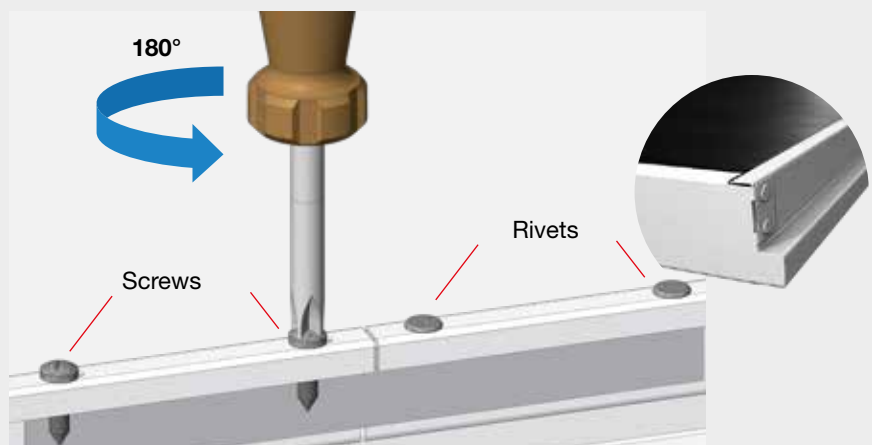

Freely suspended modules for ceiling sails

Efficient, flexible and great looks: Zehnder Carboline ceiling sails are the energy-efficient and cost-effective alternative for cooling and heating rooms in various types of building. As they only require a short space under the structural ceiling, they are even ideal for properties with low room heights. The dimensions of Zehnder Carboline ceiling sails can be tailored to suit the individual requirements of any design. Free-hanging and without a substructure, they are quick and easy to install. Additionally, they offer improved sound absorption compared with closed ceilings. With their unobtrusive design and broad colour palette, Zehnder Carboline ceiling sails are also easy on the eye.

Connecting clips for sail surfaces

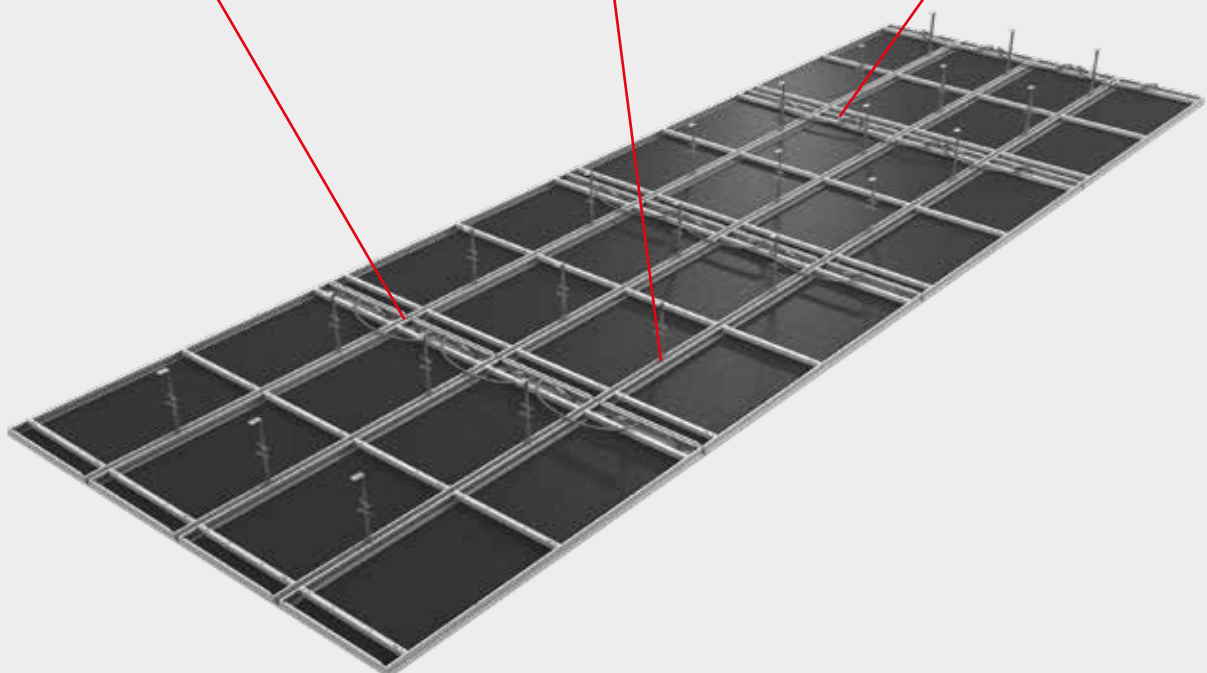

Flexible installation options

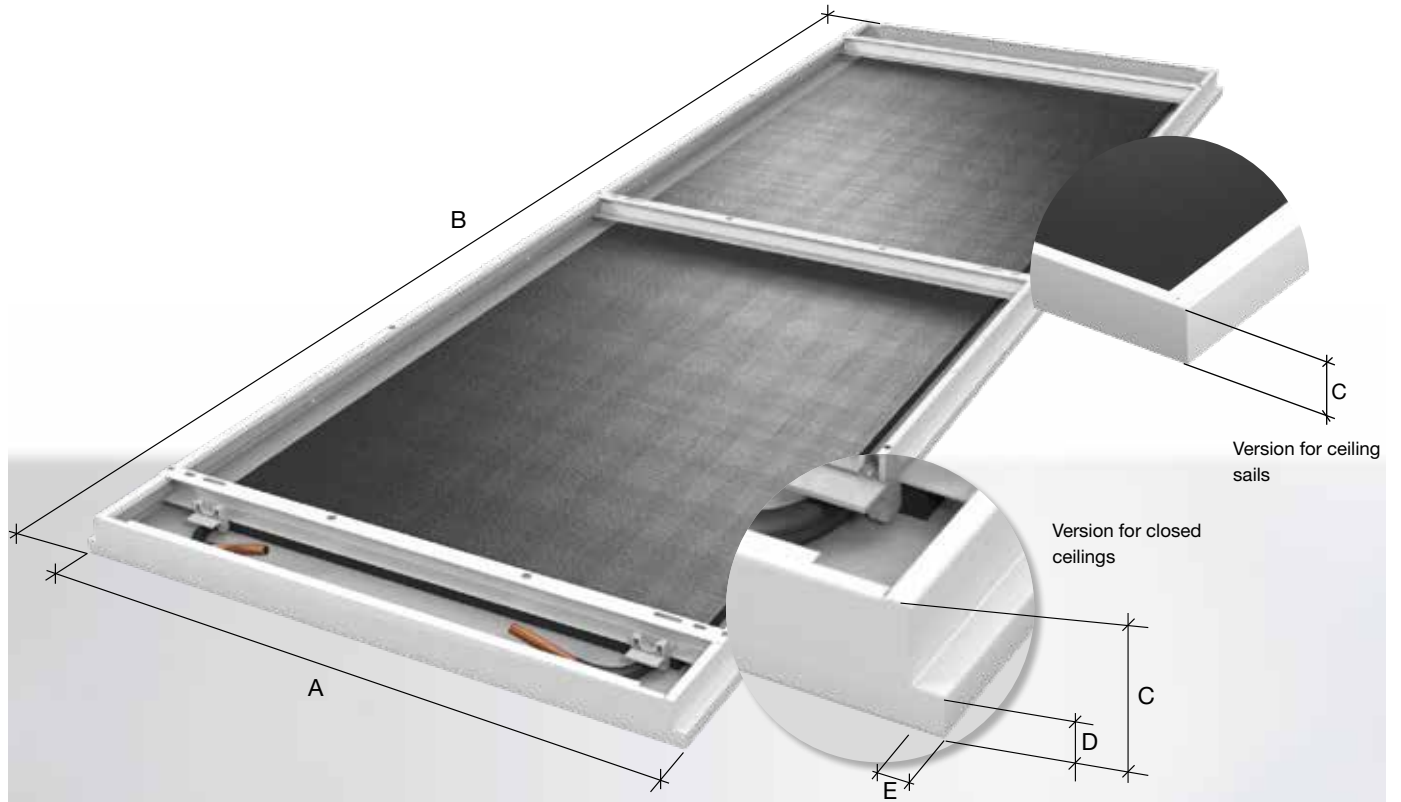

Module 600				
Dimension	Description	Unit of measurement	Lay-in module	Ceiling sails
A	Overall width	mm	595	600
B	Overall length	mm	592 - 2,992	600 - 3,000
C	Total height	mm	40	40
D	Height of the supporting edge	mm	14	-
E	Width of the supporting edge	mm	21	-

Module 625				
Dimension	Description	Unit of measurement	Lay-in module	Ceiling sails
A	Overall width	mm	620	-
B	Overall length	mm	617 - 3,117	-
C	Total height	mm	40	-
D	Height of the supporting edge	mm	14	-
E	Width of the supporting edge	mm	33	-

Modules for closed ceilings

The Zehnder Carboline heating and cooling ceiling elements are perfect for integration into all types of lay-in ceilings, especially into traditional grid ceilings (600x600 mm or 600x1,200 mm), which are often used in schools, hospitals, nurseries, retirement homes and offices. The sections come in ten standard sizes.

Special dimensions available on request.

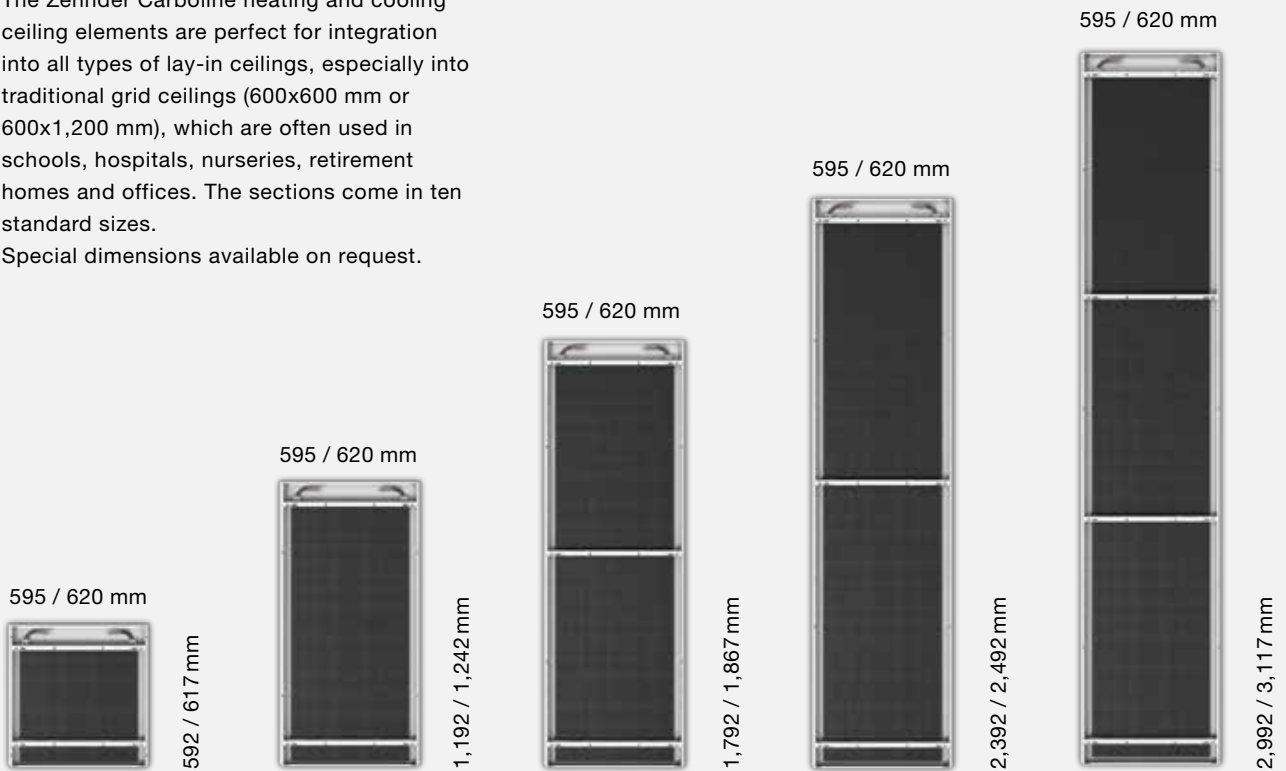

Modules for ceiling sails

The Zehnder Carboline radiant ceiling panels can be installed freely suspended. In this case, the edges are straight for aesthetic reasons. The individual sail modules can be installed very quickly and easily next to or behind each other. They also provide significant sound insulation. With their discrete design, they can be delivered on request in the RAL colour of your choice and integrated into any architectural style. This version is available in five standard sizes. Special dimensions available on request.

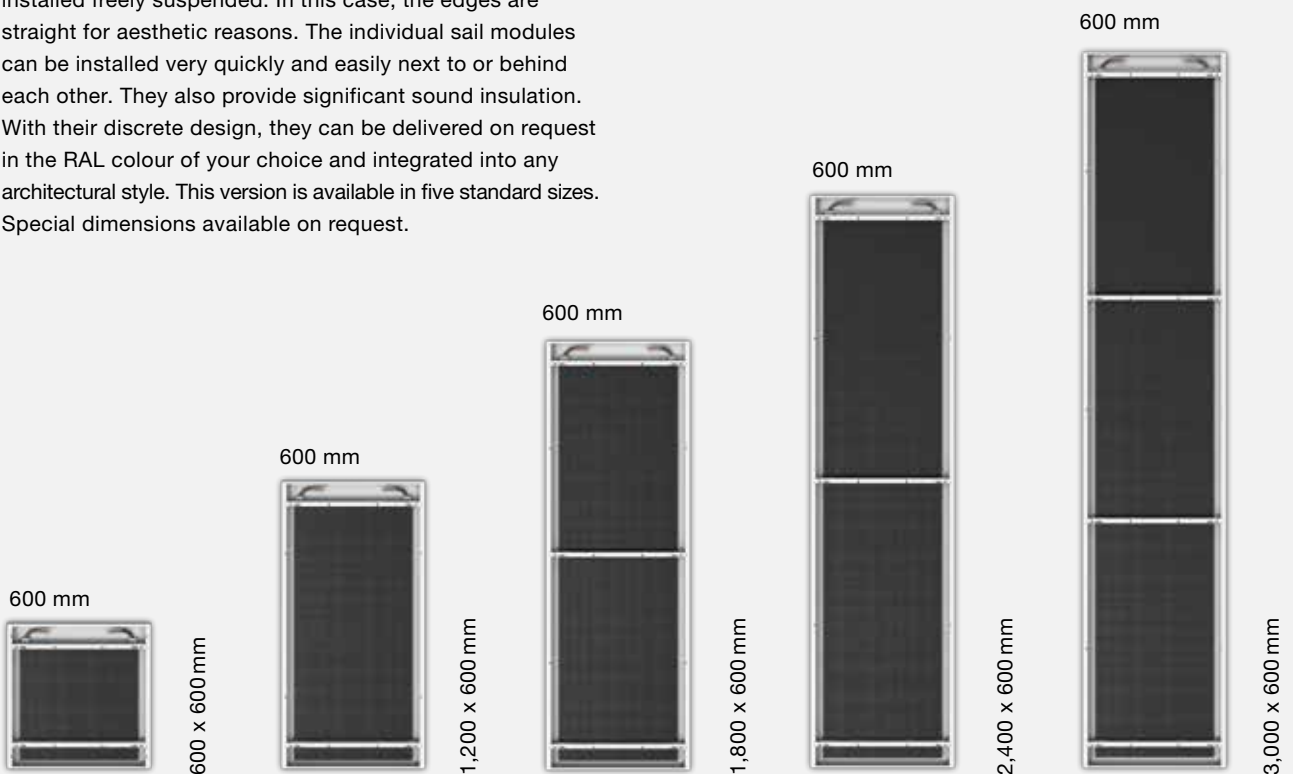

Suspension and attachment

Our various installation kits for hanging and fastening the radiant ceiling panels have not only undergone rigorous safety engineering testing but will also integrate seamlessly into your overall ceiling layout.

Standard lay-in modules



Cross anchor

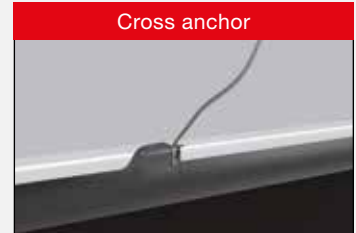

Zehnder Carboline's "grid version" is designed for installation in grid ceilings. We recommend the additional use of suspension wire to secure the panels to the ceiling.

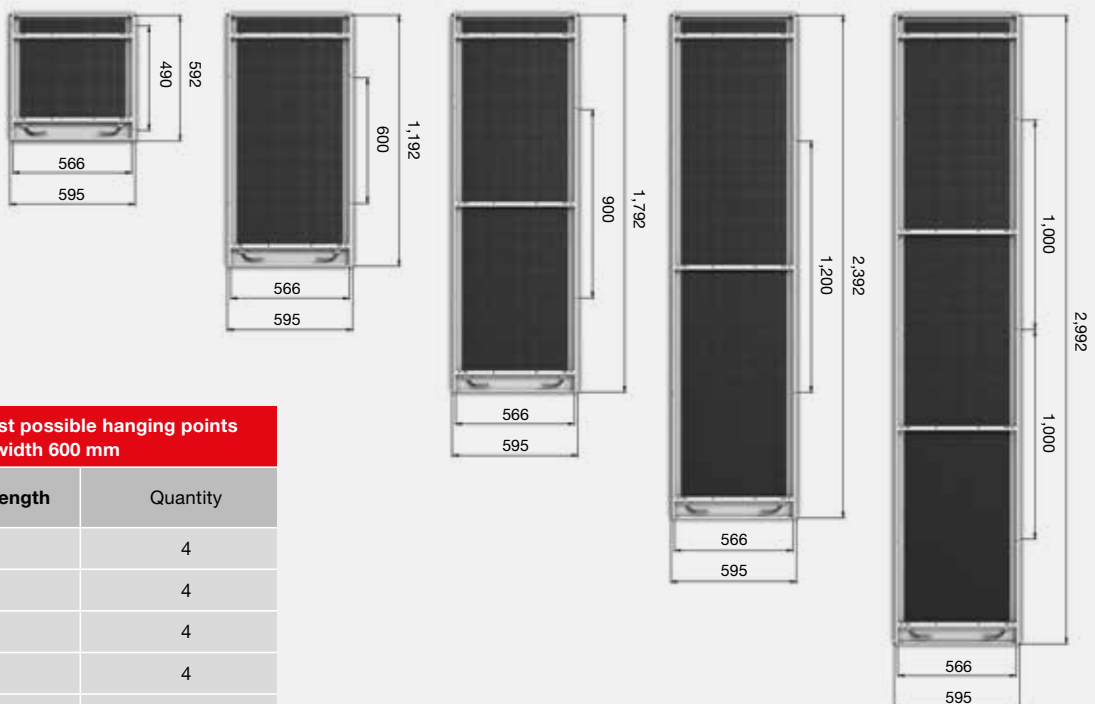

**Number of highest possible hanging points
Nominal overall width 600 mm**

Nominal overall length	Quantity
600 mm	4
1,200 mm	4
1,800 mm	4
2,400 mm	4
3,000 mm	6

Suspension system using multi-clips (sails)

The multi-clip is pushed into the lateral edge of the module. The suspension points can therefore be varied.

*See the areas specified at the bottom of the drawings.



Multi-clip with carabiner



Multi-clip with wire cable and fine adjustment

Standard sail



Long hole with fine adjustment



Cross anchor



The sail version can be attached directly to a concrete ceiling, for example. Sails of different sizes can be created by arranging the Zehnder Carboline panels in various combinations next to and in line with one another.

Fine adjustments enable the modules to be aligned exactly, which makes installation easier.

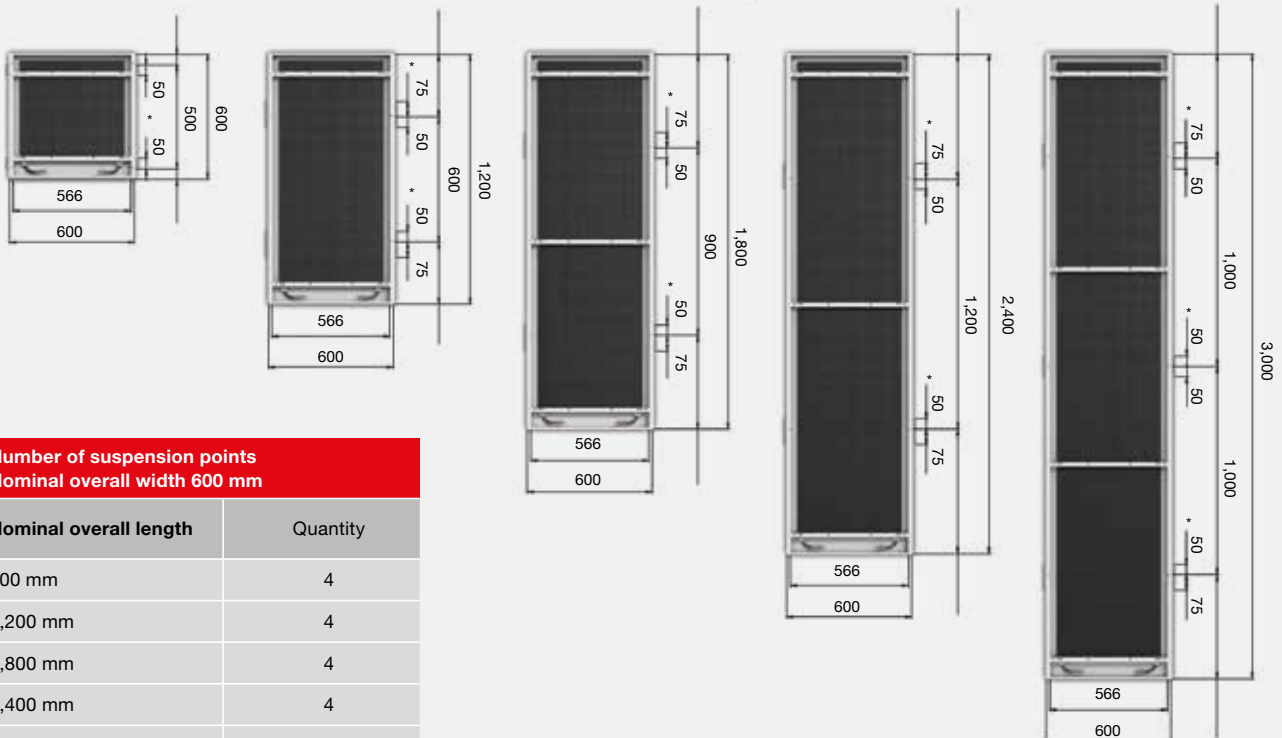

Surface finishes

Zehnder Carboline offers the option of a smooth or perforated surface. The surface is coated with a high-quality powder coat finish. Zehnder radiant ceiling panels are available in the standard colour similar to RAL 9016. Additional colours and perforations available on request.

SOUND-ABSORBING VERSION, PERFORATED PLATE

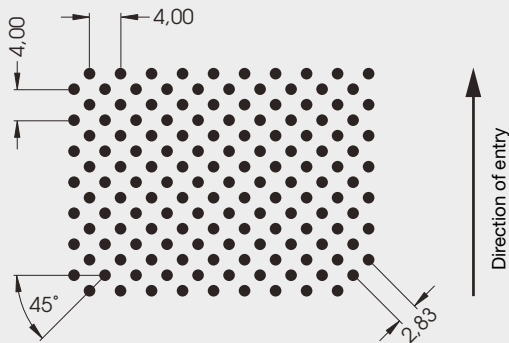

The Zehnder Carboline radiant ceiling panels can be perforated to provide optimised sound absorption. Sound waves pass through the perforations and are absorbed by the specially developed sound insulation. With sails, the sound waves are also absorbed by means of reverberation on the top of the product. This significantly reduces noise and the associated vibrations, especially in open-plan offices, call centres, schools, etc. Acoustic calculation data on request.

Hole diameter	1.5 mm
Open cross section	22%

SURFACE FINISHES

Standard colour
Smooth version, RAL 9016

More colours are available on request

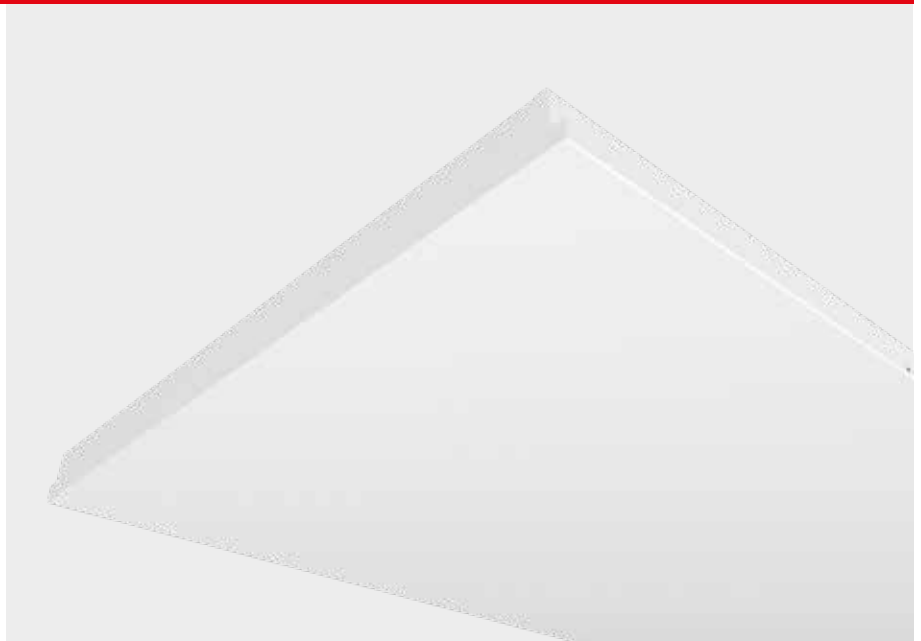

SPECIAL SOLUTIONS

Ceiling cut-outs can be integrated into the panel elements of Zehnder Carboline as required. Especially in offices or meeting rooms, it may be necessary to provide ceiling recesses, e.g. for air outlets, projector brackets, speakers, fire alarms, lighting or similar. Zehnder produces the required ceiling cut-outs precisely to the customer's specifications.

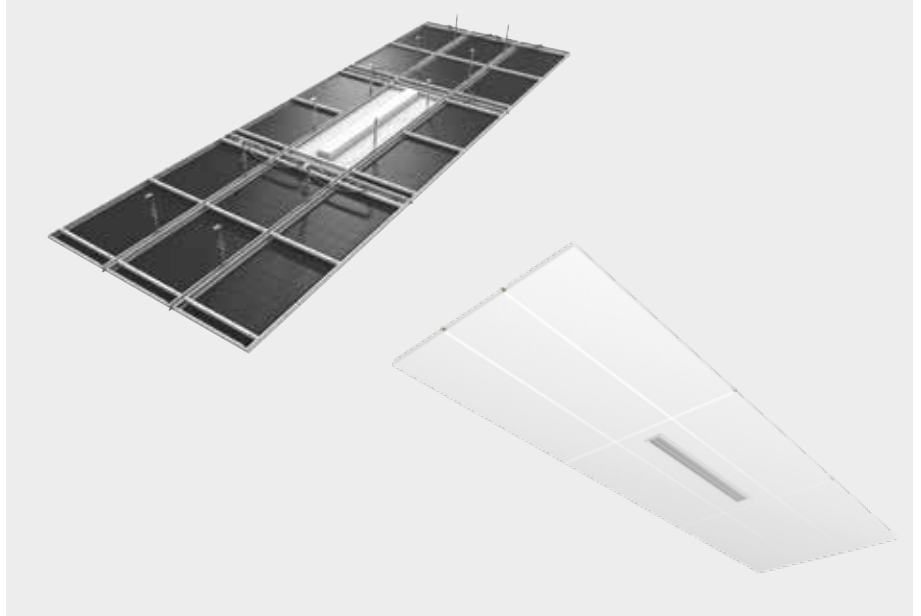

Connection technology

6-pipe rows

The Zehnder Carboline radiant ceiling panels can be installed as strips up to a maximum of 9 metres in length. In this case, the front-facing radiant ceiling panels have 2 serpentine circuits with hydraulic couplings on both sides of the panels, which enable a series connection.

Two modules next to each other with same-end connection.



Three modules behind each other with same-end connection.

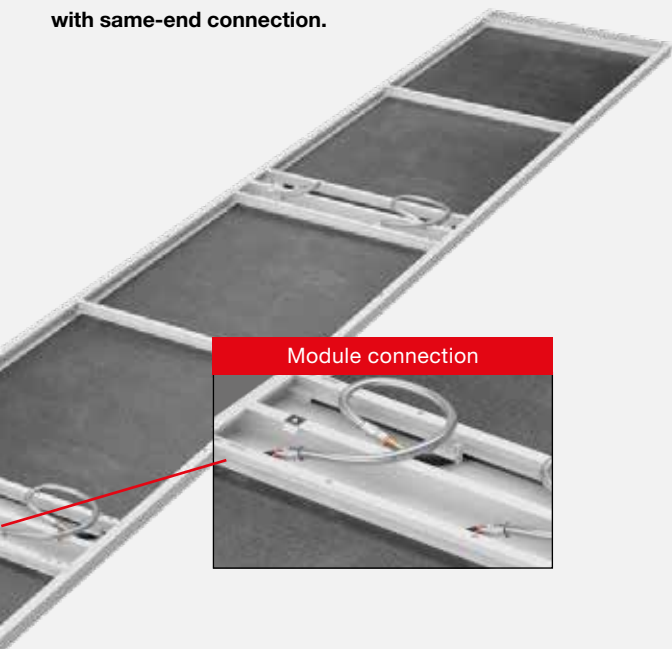

Two modules behind each other with centre connection.

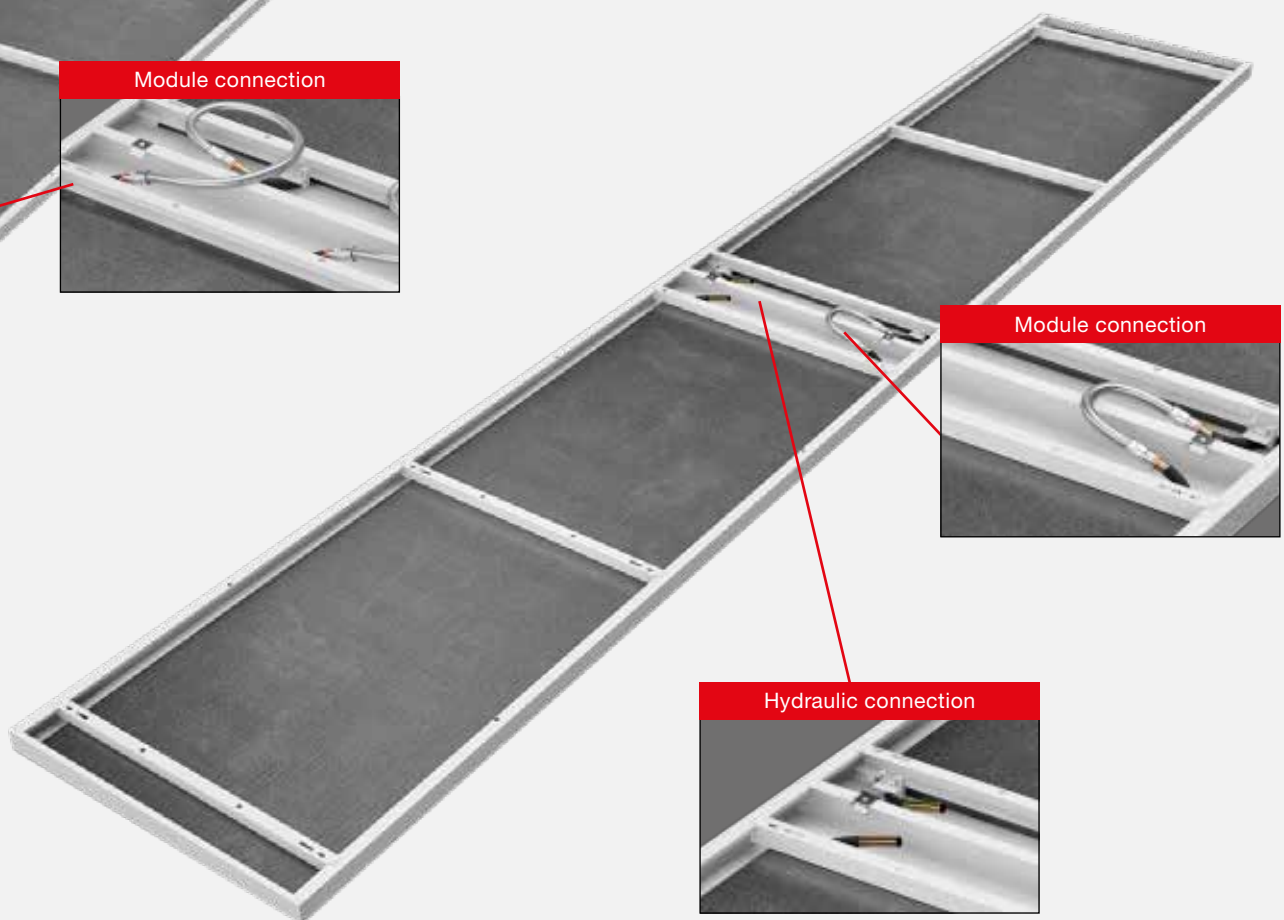

Minimum mass flow

To maintain the output shown in the table, a turbulent flow must be ensured within the pipes in the radiant panel system. This minimum mass flow depends on the lowest system temperature. When heating, this corresponds to the return temperature. When cooling or in a combined cooling/heating mode, this corresponds to the cold water flow temperature. If the minimum mass flow per pipe is not achieved, this can result in a drop in performance of up to 15%.

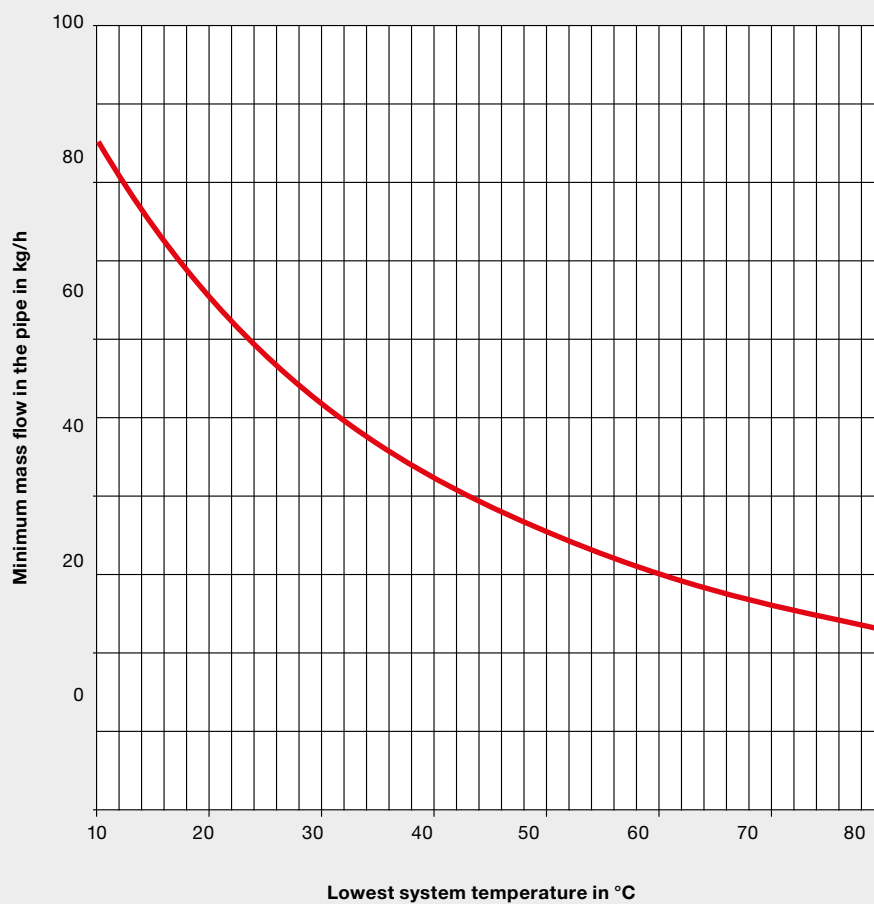

Pressure loss calculation

The pressure loss, depending on the module size and mass flow, is shown in the diagram. The maximum permitted flow speed is 0.5 m/s.

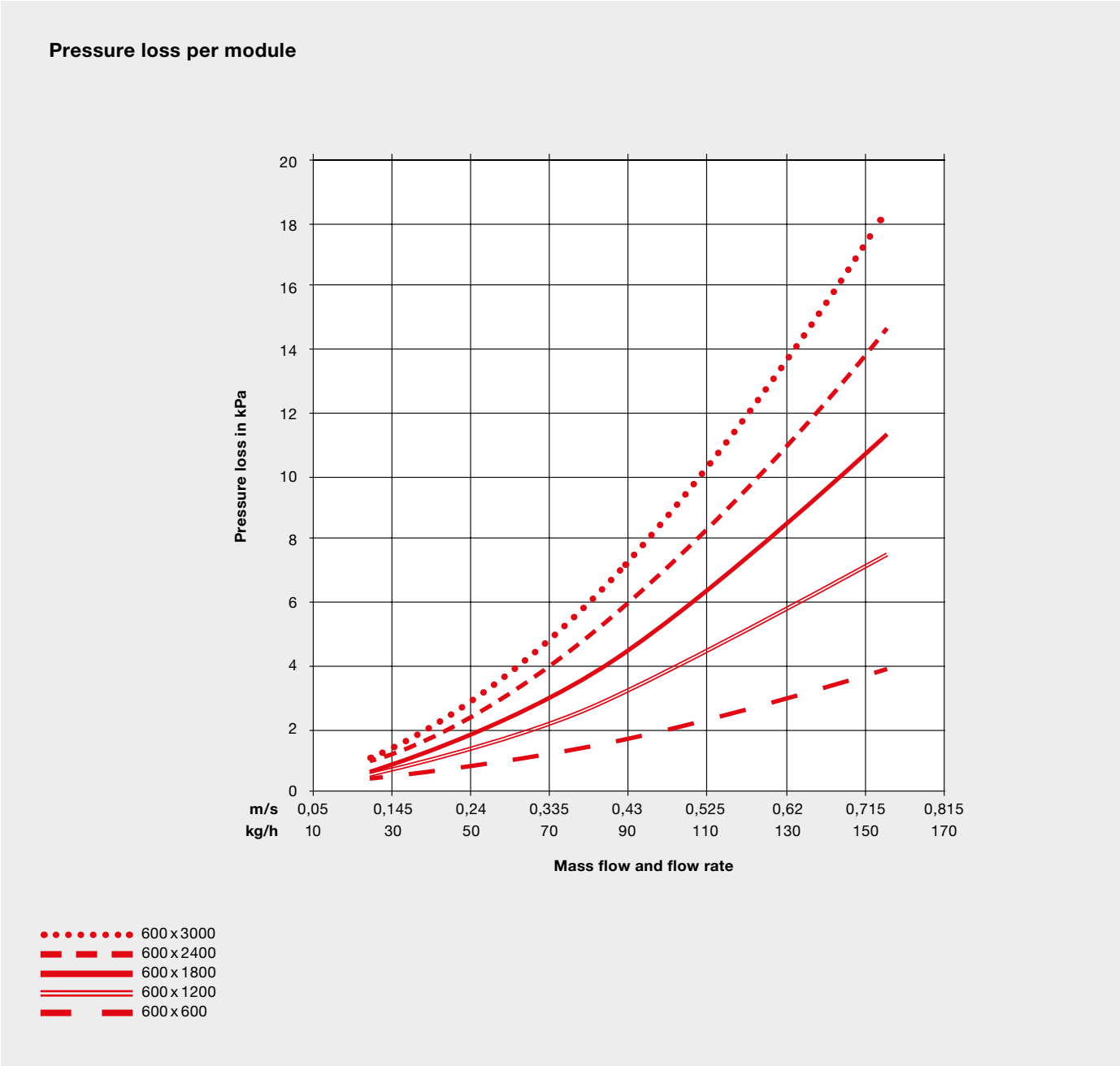

Heating and cooling performance

The following tables show the Zehnder Carboline heating and cooling performance depending on the excess and under temperatures. The values of the heat output are based on EN 14037-5, those of the cooling capacity on EN 14240.

Thermal outputs for 6-pipe activation										
Sail module / ceiling sail with insulation						Sail module / ceiling sail without insulation				
Dimensions	600 x 600	600 x 1200	600 x 1800	600 x 2400	600 x 3000	600 x 600	600 x 1200	600 x 1800	600 x 2400	600 x 3000
K	2,4242	5,4108	8,3826	11,354	14,326	2,7646	6,1706	9,5596	12,949	16,338
n			1,078					1,093		
Δ t (K)	W	W	W	W	W	W	W	W	W	W
70	236	528	817	1107	1397	287	641	993	1346	1698
68	229	511	792	1073	1354	278	621	962	1304	1645
66	222	495	767	1039	1311	269	601	932	1262	1592
64	215	479	742	1005	1268	260	581	901	1220	1539
62	207	463	717	971	1226	252	562	870	1178	1487
60	200	447	692	938	1183	243	542	839	1137	1435
58	193	431	667	904	1141	234	522	809	1096	1382
56	186	415	643	870	1098	225	502	778	1054	1330
55	182	407	630	854	1077	221	493	763	1034	1304
54	179	399	618	837	1056	216	483	748	1013	1279
52	172	383	593	804	1014	208	463	718	972	1227
50	164	367	569	770	972	199	444	688	932	1175
48	157	351	544	737	930	190	425	658	891	1124
46	150	336	520	704	888	182	405	628	850	1073
44	143	320	495	671	847	173	386	598	810	1022
42	136	304	471	638	805	164	367	568	770	971
40	129	289	447	606	764	156	348	539	730	921
38	122	273	423	573	723	147	329	509	690	871
36	115	258	399	541	682	139	310	480	651	821
34	109	242	375	508	641	130	291	451	611	771
32	102	227	352	476	601	122	273	422	572	722
30	95	212	328	444	560	114	254	393	533	673
28	88	196	304	412	520	106	236	365	494	624
26	81	181	281	381	480	97	217	337	456	575
24	75	166	258	349	441	89	199	308	418	527
22	68	151	235	318	401	81	181	280	380	479
20	61	137	212	287	362	73	163	253	342	432
18	55	122	189	256	323	65	145	225	305	385
16	48	107	167	226	285	57	128	198	268	338
14	42	93	144	195	246	49	110	171	232	292
12	35	79	122	165	209	42	93	145	196	247
10	29	65	100	136	171	34	76	118	160	202

Note: the removal of the insulation has a positive effect on the cooling capacity (see table).
 However, this additional output can only be attributed to the room if it has an open ceiling.

Removing the insulation increases the heat output, but can lead to heat accumulation under the ceiling for larger room heights.

Cooling capacities for 6-pipe activation

Sail module / ceiling sail with insulation						Sail module / ceiling sail without insulation				
Dimensions	600 x 600	600 x 1200	600 x 1800	600 x 2400	600 x 3000	600 x 600	600 x 1200	600 x 1800	600 x 2400	600 x 3000
K	2,9974	6,6903	10,365	14,039	17,714	3,45	7,7006	11,93	16,159	20,388
n			1,093					1,094		
Δ t (K)	W	W	W	W	W	W	W	W	W	W
15	58	129	200	271	342	67	149	231	313	394
14	54	120	185	251	317	62	138	214	290	366
13	49	110	171	232	292	57	127	197	267	337
12	45	101	157	212	268	52	117	181	245	309
11	41	92	142	193	244	48	106	164	223	281
10	37	83	128	174	219	43	96	148	201	253
9	33	74	114	155	196	38	85	132	179	226
8	29	65	101	136	172	34	75	116	157	198
7	25	56	87	118	149	29	65	100	136	171
6	21	47	73	100	126	24	55	85	115	145
5	17	39	60	82	103	20	45	69	94	119
4	14	30	47	64	81	16	35	54	74	93
3	10	22	34	47	59	11	26	40	54	68
2	6	14	22	30	38	7	16	25	34	44
1	3	7	10	14	18	3	8	12	16	20

Heating and cooling performance

The following tables show the Zehnder Carboline heating and cooling performance depending on the excess and under temperatures. The values of the heat output are based on EN 14037-5, those of the cooling capacity on EN 14240.

Thermal outputs for 6-pipe activation										
Lay-in module with insulation						Lay-in module without insulation				
Dimensions	595 x 592	595 x 1192	595 x 1792	595 x 2392	595 x 2992	595 x 592	595 x 1192	595 x 1792	595 x 2392	595 x 2992
K	1,8634	4,1592	6,4436	8,7279	11,012	1,9193	4,2839	6,6367	8,9895	11,342
n			1,072					1,069		
Δ t (K)	W	W	W	W	W	W	W	W	W	W
70	177	395	612	830	1047	180	402	623	844	1064
68	172	383	594	804	1015	175	390	604	818	1032
66	166	371	575	779	983	169	378	585	792	999
64	161	359	556	754	951	164	365	566	767	967
62	156	347	538	728	919	158	353	547	741	935
60	150	335	519	703	887	153	341	528	715	903
58	145	323	501	678	856	147	329	509	690	871
56	139	311	482	653	824	142	317	491	665	838
55	137	305	473	641	808	139	311	481	652	823
54	134	299	464	628	792	136	305	472	639	807
52	129	287	445	603	761	131	293	453	614	775
50	123	276	427	578	730	126	281	435	589	743
48	118	264	409	554	698	120	269	416	564	711
46	113	252	390	529	667	115	257	398	539	679
44	108	240	372	504	636	110	245	379	514	648
42	102	229	354	480	605	104	233	361	489	617
40	97	217	336	455	574	99	221	342	464	585
38	92	205	318	431	544	94	209	324	439	554
36	87	194	300	407	513	88	197	306	414	523
34	82	182	282	383	483	83	186	288	390	492
32	77	171	265	358	452	78	174	270	365	461
30	71	159	247	334	422	73	163	252	341	430
28	66	148	229	311	392	68	151	234	317	400
26	61	137	212	287	362	62	139	216	293	369
24	56	125	194	263	332	57	128	198	269	339
22	51	114	177	240	303	52	117	181	245	309
20	46	103	160	217	273	47	105	163	221	279
18	41	92	143	193	244	42	94	146	198	249
16	36	81	126	171	215	37	83	129	174	220
14	32	70	109	148	186	32	72	111	151	191
12	27	60	92	125	158	27	61	95	128	162
10	22	49	76	103	130	22	50	78	105	133

Note: the removal of the insulation has a positive effect on the cooling capacity (see table).
 However, this additional output can only be attributed to the room if it has an open ceiling.

Removing the insulation increases the heat output, but can lead to heat accumulation under the ceiling for larger room heights.

Cooling capacities for 6-pipe activation										
Lay-in module with insulation						Lay-in module without insulation				
Dimensions	595 x 592	595 x 1192	595 x 1792	595 x 2392	595 x 2992	595 x 592	595 x 1192	595 x 1792	595 x 2392	595 x 2992
K	2,3658	5,2805	8,1806	11,081	13,981	2,4672	5,5068	8,5313	11,556	14,58
n			1,106					1,094		
Δ t (K)	W	W	W	W	W	W	W	W	W	W
15	47	106	164	221	279	48	107	165	224	282
14	44	98	151	205	259	44	99	153	207	262
13	40	90	140	189	239	41	91	141	191	241
12	37	82	128	173	218	37	83	129	175	221
11	34	75	116	157	198	34	76	118	159	201
10	30	67	104	141	178	31	68	106	143	181
9	27	60	93	126	159	27	61	94	128	161
8	24	53	82	111	139	24	54	83	112	142
7	20	45	70	95	120	21	46	72	97	123
6	17	38	59	80	101	18	39	61	82	104
5	14	31	49	66	83	14	32	50	67	85
4	11	24	38	51	65	11	25	39	53	66
3	8	18	28	37	47	8	18	28	38	48
2	5	11	18	24	30	5	12	18	25	31
1	2	5	8	11	14	2	6	9	12	15

Zehnder Carboline technical specifications

		Lay-in module					Sail module				
Dimensions	Unit of measurement										
Type width	-	600 / 625					600				
Type length	-	600 / 625	1,200 / 1,250	1,800 / 1,875	2,400 / 2,500	3,000 / 3,125	600	1,200	1,800	2,400	3,000
Actual width	mm	595 / 620					600				
Actual length	mm	592 / 617	1,192 / 1,242	1,792 / 1,867	2,392 / 2,492	2,992 / 3,117	600	1,200	1,800	2,400	3,000
Number of suspension points per module	piece(s)	4	4	4	4	6	4	4	4	4	6
No. of parallel pipes	piece(s)	6					6				
Pipe spacing	mm	90					90				
Pipe material / dimension (outside ø)	- / mm	copper pipe / 10					copper pipe / 10				
Panel material	-	Galvanised steel					Galvanised steel				

Parameters

Max. operating temperature ¹⁾	°C	50					50				
Max. operating pressure ²⁾	bar	6					6				

Weight

Operating weight without water, with insulation	kg	4.56 / 4.84	8.15 / 8.66	12.04 / 12.78	15.62 / 16.60	19.51 / 20.61	4.56	8.15	12.04	15.62	19.51
Operating weight with water, with insulation ³⁾	kg	4.77 / 5.07	8.59 / 9.13	12.71 / 13.49	16.52 / 17.55	20.64 / 21.80	4.77	8.59	12.71	16.52	20.64

¹⁾ Higher operating temperature on request.

²⁾ Higher operating pressure on request.

³⁾ Insulation made of mineral wool in LDPE foil, mass per unit area = 0.84 kg/m², λ = 0.03 - 0.04 W/(m*K)

Tender specification

Ceiling sail – free-hanging modules

Carboline sail version ... x ... mm, active
(standard modules: 600 x 600 mm; 600 x 1,200 mm;
600 x 1,800 mm; 600 x 2,400 mm; 600 x 3,000 mm)
Carboline sail version ... x ... mm, active
(bespoke version)

Metal ceiling panels according to the TAIM e.V. quality standard.

Version: November 1998, material: galvanised sheet steel, minimum thickness 0.7 mm, lip on longitudinal side in line with static requirements.

Surface similar to RAL ... (9016), smooth surface similar to RAL ... (9016), perforated, hole pattern ... RD - L30 (1.5 mm - 22% - 45°), surrounding non-perforated edge, approx. 10 mm wide.

A special heat-conducting acoustic fleece has been force-fitted to the back of the perforated version, without pleats, to improve sound absorption. The supplier must present test results to prove that sound absorption is achieved in conjunction with the metal ceiling panels on offer.

Sound absorption measured according to EN ISO 345.

Fixing:

Fixing to the bare ceiling via metal anchors approved by the building authorities, with a maximum load of at least 0.5 kN per anchor. Suspension via galvanised nonius suspending brackets and transverse profiles, can be folded down.

Suspension height from bottom edge of reinforced concrete ceiling to bottom edge of metal cassette approx. 300 mm.

All parts made of galvanised sheet steel.

Insulation:

Heat and sound-absorbing insulating layer, based on mineral wool, coated with black fleece on one side and shrink-wrapped in LDPE foil.

Cooling register:

Cooling and heating element comprises a sheet steel cassette and a graphite element containing a copper pipe. The copper pipes (diam. 10 mm, pipe spacing 90 mm) are fitted in a compressed graphite panel in an interlocking manner. This allows very quick, even and very good thermal conductivity to be achieved across the entire area of the element.

This high-performance element is firmly bonded to a sendzimir-galvanised sheet steel cassette. The deburred pipe ends are screwed to the cassette using special axles in order to guarantee strain and pressure relief.

Chamfers and reinforcement profiles are used to provide static reinforcement of the sheet steel cassette. The visible side is coated with a high-grade polyester fine-structure paint.

The cooling ceilings must be hydraulically connected so there is a maximum pressure loss of 25 kPa per control circuit.

Heating technical specification:

For example:

Room temperature:	20 °C
Hot water flow:	40 °C
Hot water return:	36 °C
Thermal output:	approx. 164 W/m ² based on EN 14037-2

Cooling technical specification:

For example:

Room temperature:	26 °C
Cooling water flow:	16 °C
Cooling water return:	19 °C
Cooling capacity:	approx. 95 W/m ² based on EN 14240

Sails consisting of module sizes: ... pieces ... x ... mm

Material: galvanised sheet steel, similar to RAL ... (9016), perforated or smooth, including insulation

Smooth version:

Maximum operating temperature:	83 °C
Maximum operating pressure:	6 bar

Perforated version:

Maximum operating temperature:	50 °C
Maximum operating pressure:	6 bar

Tender specification

Lay-in modules for T24 grid ceiling

All positions below cover the materials supplied for a T24 ceiling construction.

Heating and cooling ceiling modules for a T24 grid ceiling

As flush lay-in metal cassettes for a visible T24 track supporting structure for heating and cooling, in a perforated / smooth version, for removing sensitive heat loads in an approximate ratio of 60% via radiation and 40% via convection.

A minimum suspension height of 350 mm (bottom edge of bare ceiling to upper edge of heating and cooling ceiling) is required.

Components and additional loads must be suspended from the bare ceiling separately; alternatively, they can be attached by means of reinforcements on the back of the panels, additional profiles and additional suspending brackets on the substructure. The supplementary work must be carried out professionally.

Tolerances and quality requirements according to TAIM e.V.

Hydraulic pipework for the individual metal cassettes as per the room-specific calculations. The Tichelmann ring is installed on the room side by others on the building site. Hoses connected to the outlet connectors of the pipework on the room side by 10 mm outlets.

Zehnder Carboline active:

Metal ceiling panels according to the TAIM e.V. quality standard.

Version: November 1998, material: galvanised sheet steel, minimum thickness 0.6 mm, lip on longitudinal side in line with static requirements. Surface similar to RAL ... (9016), perforated, hole pattern RD - L30 (diameter 1.5 mm – open cross section 22% - 45°); surrounding non-perforated edge, approx. 10 mm wide.

A special heat-conducting acoustic fleece has been force-fitted to the back, without pleats, to improve sound absorption. The supplier must present test results to prove that sound absorption is achieved in conjunction with the metal ceiling panels on offer.

Sound absorption measured according to EN ISO 345.

Inserted thermal insulation as a heat and sound-absorbing insulating layer, based on mineral wool, flame-resistant, classified as Euroclass B1 and tested to EN 13501-1. Placed over the entire copper pipe register.

The copper pipes (diam. 10 mm, pipe spacing 90 mm) are fitted in a compressed graphite panel in an interlocking manner. This allows very quick, even and very good thermal conductivity to be achieved across the entire area of the element.

This high-performance element is firmly bonded to a sendzimir-galvanised sheet steel cassette. The deburred pipe ends are screwed to the cassette using special axles in order to guarantee strain and pressure relief. Chamfers and reinforcement profiles are used to provide static reinforcement of the sheet steel cassette. The visible side is coated with a high-grade polyester fine-structure paint.

The cooling ceilings must be hydraulically connected so there is a maximum pressure loss of 25 kPa per control circuit.

In line with the pressure loss stated above, a corresponding number of radiant panel systems must be connected in series, then connected to the distribution pipe in parallel.

Heating technical specification:

For example:

Room temperature:	20 °C
Hot water flow:	34 °C
Hot water return:	30 °C
Thermal output:	approx. 84 W/m ² based on EN 14037-5

Cooling technical specification:

For example:

Room temperature:	26 °C
Cooling water flow:	16 °C
Cooling water return:	19 °C
Cooling capacity:	approx. 80 W/m ² based on EN 14240

All given performance values must be verified by an official test report from an independent institute.

Module size of the linear panel active: ... mm x ... mm

Standard width 595 mm (600 mm)

Standard width 620 mm (625 mm)

Material: galvanised sheet steel, similar to RAL ... (9016), perforated or smooth

Smooth version:

Maximum operating temperature:	83 °C
Maximum operating pressure:	6 bar

Perforated version:

Maximum operating temperature:	50 °C
Maximum operating pressure:	6 bar

Accessories

Hose connection 10 x 10 mm

Flexible connector, with oxygen barrier, stainless steel braid, brass plug-in connectors and pressed on both sides. Plastic plug-in connectors are not permitted. Plug-in connector on both sides for copper pipe (10 mm).

The copper pipes used on site to connect the flexible connection pipes must meet the requirements of EN 1057. Only copper pipes in the conditions R220 (soft) and R250 (half hard) are permitted.

- Tight against diffusion according to DIN 4726

Maximum operating temperature: 80 °C

Maximum operating pressure: 6 bar

Length: ... mm (1,000 mm, 1,500 mm, ...)

Hose connection 10 x ½" female thread as coupler

Flexible connector, with oxygen barrier, stainless steel braid with brass plug-in connector pressed on one side and ½" female thread as coupler, flat gasket.

Plastic plug-in connectors are not permitted.

Plug-in connector for copper pipe (10 mm).

- Tight against diffusion according to DIN 4726

Maximum operating temperature: 80 °C

Maximum operating pressure: 6 bar

Length: ... mm (500 mm, 750 mm, ...)

Fixing:

Suspension system with auto-blocking zinc housing for concrete ceiling, wire cable 1.5 mm with cross brace (distance below concrete ceiling 1 m)

Anchorage in concrete: hexagon nut, drive-in anchor, eyelet screw, galvanised steel.

Fine adjustment consisting of:

M6 threaded bolt with 2.5 mm drill hole along the entire length and cross brace with M6 female thread; thread length 25 mm

ALWAYS THE BEST CLIMATE

“We strive to improve the quality of life by providing the finest indoor climate solutions.”



Excellent team

Every day we combine passion, expert knowledge and commitment to give you the best results.



Great solutions, products and services

Great products and unique service for an energy-efficient, healthy and comfortable indoor climate.

WE ARE THE SPECIALISTS FOR A HEALTHY, COMFORTABLE AND ENERGY-EFFICIENT

The broad and clearly structured portfolio from the Zehnder Group is split into four product lines. Consequently, we can provide our customers with the right product, perfect system and matching service for all types of projects – from new build to renovations, single or multi-occupancy homes, as well as commercial projects. This variety ensures that our wealth of experience is continuously expanding, providing tangible added value to our customers on a daily basis.



Decorative radiators

Our individual decorative radiators for living and bathrooms make a home not only warmer but also more attractive. Created by renowned designers, they impress with excellent functionality.

OUR BRANDS REPRESENT INNOVATION, QUALITY AND DESIGN

zehnder

The Zehnder brand offers excellent indoor climate solutions within the product lines of decorative radiators, comfortable indoor ventilation, heating and cooling ceiling systems and clean air solutions.

runtal

The Runtal brand develops and manufactures exclusive radiators combining innovative technologies with unique designs.

INNOVATION OVER 4 GENERATIONS



First choice for customers

Always close to the needs of our customers, to grow with you and overcome all challenges together.

MANUFACTURER OF THE WORLD'S

1st

STEEL AND BATHROOM RADIATORS

REPRESENTED IN MORE THAN

70 COUNTRIES

MORE THAN **3,000** EMPLOYEES

15 OF OUR OWN PRODUCTION PLANTS IN EUROPE, NORTH AMERICA AND CHINA

INNOVATION SINCE **1895**

830 PATENTS AND DESIGN RIGHTS THROUGHOUT THE WORLD

MORE THAN **20,000** TRAINED CUSTOMERS PER YEAR

INDOOR CLIMATE



Comfortable indoor ventilation

Our comfortable indoor ventilation is energy-efficient and provides a healthy indoor climate. It promotes the wellbeing of the occupants and increases the value of the property.



Heating and cooling ceiling systems

Zehnder ceiling systems are convenient and energy-efficient for heating and cooling. They are perfectly attuned to the relevant environment.



Clean air solutions

Clean air systems from Zehnder reduce the level of dust in the air, create a healthier working environment and reduce the amount of cleaning required.

BEST QUALITY CERTIFICATES

Remqui acepele ntiistem doluptus volector sedio. Optas ape dolorem porest, suntenemodis aut pere, nestion consequia consequa de plit, quid ea dunt.

Zehnder Group products are frequently awarded prizes for design and innovative technology.



